



**CALL NO. 332**

**CONTRACT ID. 192147**

**MCCREARY COUNTY**

**FED/STATE PROJECT NUMBER FD05 074 0027 000-005**

**DESCRIPTION TENNESSEE TO PINE KNOT ROAD (US 27)**

**WORK TYPE ASPHALT RESURFACING**

**PRIMARY COMPLETION DATE 11/15/2019**

**LETTING DATE: April 26,2019**

Sealed Bids will be received electronically through the Bid Express bidding service until 10:00 AM EASTERN DAYLIGHT TIME April 26,2019. Bids will be publicly announced at 10:00 AM EASTERN DAYLIGHT TIME.

**NO PLANS ASSOCIATED WITH THIS PROJECT.**

**REQUIRED BID PROPOSAL GUARANTY:** Not less than 5% of the total bid.

## TABLE OF CONTENTS

PART I	SCOPE OF WORK
	<ul style="list-style-type: none"><li>• PROJECT(S), COMPLETION DATE(S), &amp; LIQUIDATED DAMAGES</li><li>• CONTRACT NOTES</li><li>• STATE CONTRACT NOTES</li><li>• NATIONAL HIGHWAY</li><li>• SURFACING AREAS</li><li>• ASPHALT MIXTURE</li><li>• INCIDENTAL SURFACING</li><li>• FUEL AND ASPHALT PAY ADJUSTMENT</li><li>• COMPACTION OPTION A</li><li>• MATERIAL TRANSFER VEHICLE (MTV)</li><li>• SPECIAL NOTE(S) APPLICABLE TO PROJECT</li><li>• EDGE KEY (BY TON)</li><li>• ASPHALT MILLING AND TEXTURING</li><li>• TYPICAL SECTION DIMENSIONS</li><li>• TRAFFIC CONTROL PLAN 4 LANE</li><li>• DURABLE PAVEMENT EDGE DETAILS</li><li>• TRAFFIC SIGNAL LOOP DETECTORS</li><li>• SKETCH MAP(S)</li><li>• SUMMARY SHEET(S)</li><li>• TYPICAL SECTION(S)</li></ul>
PART II	SPECIFICATIONS AND STANDARD DRAWINGS
	<ul style="list-style-type: none"><li>• SPECIFICATIONS REFERENCE</li><li>• SUPPLEMENTAL SPECIFICATION</li><li>• [SN-1I] PORTABLE CHANGEABLE SIGNS</li><li>• 2016 STANDARD DRAWINGS THAT APPLY</li><li>• CENTERLINE RUMBLE STRIPS</li><li>• CENTERLINE RUMBLE STRIP 4 INCH STRIPING</li><li>• SHOULDER AND EDGE LINE RUMBLE STRIP DETAILS</li><li>• SHOULDER RUMBLE STRIP DETAILS TWO LANE ROADWAYS</li></ul>
PART III	EMPLOYMENT, WAGE AND RECORD REQUIREMENTS
	<ul style="list-style-type: none"><li>• LABOR AND WAGE REQUIREMENTS</li><li>• EXECUTIVE BRANCH CODE OF ETHICS</li><li>• KENTUCKY EQUAL EMPLOYMENT OPPORTUNITY ACT OF 1978 LOCALITY / STATE</li><li>• PROJECT WAGE RATES / STATE</li></ul>
PART IV	INSURANCE
PART V	BID ITEMS

**PART I**  
**SCOPE OF WORK**

## ADMINISTRATIVE DISTRICT - 08

**CONTRACT ID - 192147**

**FD05 074 0027 000-005**

**COUNTY - MCCREARY**

**PCN - MP07400271901**

**FD05 074 0027 000-005**

TENNESSEE TO PINE KNOT ROAD (US 27) (MP 0.000) BEGIN AT THE KENTUCKY/TENNESSEE STATE LINE  
EXTENDING NORTH TO THE INTERSECTION OF US 27 AND KY 1651/KY 2792 (MP 4.608), A DISTANCE OF 04.60  
MILES.ASPHALT RESURFACING

GEOGRAPHIC COORDINATES LATITUDE 36:38:08.16 LONGITUDE 84:26:03.34

**COMPLETION DATE(S):**

COMPLETED BY 11/15/2019

APPLIES TO ENTIRE CONTRACT

## **CONTRACT NOTES**

### **PROPOSAL ADDENDA**

All addenda to this proposal must be applied when calculating bid and certified in the bid packet submitted to the Kentucky Department of Highways. Failure to use the correct and most recent addenda may result in the bid being rejected.

### **BID SUBMITTAL**

Bidder must use the Department's electronic bidding software. The Bidder must download the bid file located on the Bid Express website ([www.bidx.com](http://www.bidx.com)) to prepare a bid packet for submission to the Department. The bidder must submit electronically using Bid Express.

### **JOINT VENTURE BIDDING**

Joint venture bidding is permissible. All companies in the joint venture must be prequalified in one of the work types in the Qualifications for Bidders for the project. The bidders must get a vendor ID for the joint venture from the Division of Construction Procurement and register the joint venture as a bidder on the project. Also, the joint venture must obtain a digital ID from Bid Express to submit a bid. A joint bid bond of 5% may be submitted for both companies or each company may submit a separate bond of 5%.

### **UNDERGROUND FACILITY DAMAGE PROTECTION**

The contractor shall make every effort to protect underground facilities from damage as prescribed in the Underground Facility Damage Protection Act of 1994, Kentucky Revised Statute KRS 367.4901 to 367.4917. It is the contractor's responsibility to determine and take steps necessary to be in compliance with federal and state damage prevention directives. When prescribed in said directives, the contractor shall submit Excavation Locate Requests to the Kentucky Contact Center (KY811) via web ticket entry. The submission of this request does not relieve the contractor from the responsibility of contacting non-member facility owners, whom shall be contacted through their individual Protection Notification Center. Non-compliance with these directives can result in the enforcement of penalties.

### **REGISTRATION WITH THE SECRETARY OF STATE BY A FOREIGN ENTITY**

Pursuant to KRS 176.085(1)(b), an agency, department, office, or political subdivision of the Commonwealth of Kentucky shall not award a state contract to a person that is a foreign entity required by [KRS 14A.9-010](#) to obtain a certificate of authority to transact business in the Commonwealth ("certificate") from the Secretary of State under [KRS 14A.9-030](#) unless the person produces the certificate within fourteen (14) days of the bid or proposal opening. If the foreign entity is not required to obtain a certificate as provided in [KRS 14A.9-010](#), the foreign entity should identify the applicable exception. Foreign entity is defined within [KRS 14A.1-070](#).

**For all foreign entities required to obtain a certificate of authority to transact business in the Commonwealth, if a copy of the certificate is not received by the contracting agency within the time frame identified above, the foreign entity's solicitation response shall be deemed non-responsive or the awarded contract shall be cancelled.**

Businesses can register with the Secretary of State at <https://secure.kentucky.gov/sos/ftbr/welcome.aspx>.

#### **SPECIAL NOTE FOR PROJECT QUESTIONS DURING ADVERTISEMENT**

Questions about projects during the advertisement should be submitted in writing to the Division of Construction Procurement. This may be done by fax (502) 564-7299 or email to [kytc.projectquestions@ky.gov](mailto:kytc.projectquestions@ky.gov). The Department will attempt to answer all submitted questions. The Department reserves the right not to answer if the question is not pertinent or does not aid in clarifying the project intent.

The deadline for posting answers will be 3:00 pm Eastern Daylight Time, the day preceding the Letting. Questions may be submitted until this deadline with the understanding that the later a question is submitted, the less likely an answer will be able to be provided.

The questions and answers will be posted for each Letting under the heading "Questions & Answers" on the Construction Procurement website ([www.transportation.ky.gov/contract](http://www.transportation.ky.gov/contract)). The answers provided shall be considered part of this Special Note and, in case of a discrepancy, will govern over all other bidding documents.

#### **HARDWOOD REMOVAL RESTRICTIONS**

The US Department of Agriculture has imposed a quarantine in Kentucky and several surrounding states, to prevent the spread of an invasive insect, the emerald ash borer. Hardwood cut in conjunction with the project may not be removed from the state. Chipping or burning on site is the preferred method of disposal.

#### **INSTRUCTIONS FOR EXCESS MATERIAL SITES AND BORROW SITES**

Identification of excess material sites and borrow sites shall be the responsibility of the Contractor. The Contractor shall be responsible for compliance with all applicable state and federal laws and may wish to consult with the US Fish and Wildlife Service to seek protection under Section 10 of the Endangered Species Act for these activities.

#### **ACCESS TO RECORDS**

The contractor, as defined in KRS 45A.030 (9) agrees that the contracting agency, the Finance and Administration Cabinet, the Auditor of Public Accounts, and the Legislative Research Commission, or their duly authorized representatives, shall have access to any books, documents, papers, records, or other evidence, which are directly pertinent to this contract for the purpose of financial audit or program review. Records and other prequalification information confidentially

disclosed as part of the bid process shall not be deemed as directly pertinent to the contract and shall be exempt from disclosure as provided in KRS 61.878(1)(c). The contractor also recognizes that any books, documents, papers, records, or other evidence, received during a financial audit or program review shall be subject to the Kentucky Open Records Act, KRS 61.870 to 61.884.

In the event of a dispute between the contractor and the contracting agency, Attorney General, or the Auditor of Public Accounts over documents that are eligible for production and review, the Finance and Administration Cabinet shall review the dispute and issue a determination, in accordance with Secretary's Order 11-004.

April 30, 2018

## **SPECIAL NOTE FOR RECIPROCAL PREFERENCE**

### **RECIPROCAL PREFERENCE TO BE GIVEN BY PUBLIC AGENCIES TO RESIDENT BIDDERS**

By reference, KRS 45A.490 to 45A.494 are incorporated herein and in compliance regarding the bidders residency. Bidders who want to claim resident bidder status should complete the Affidavit for Claiming Resident Bidder Status along with their bid in the electronic bidding software. Submittal of the Affidavit should be done along the bid in Bid Express.

April 30, 2018



### **NATIONAL HIGHWAY**

Be advised this project is on the NATIONAL HIGHWAY SYSTEM.

### **SURFACING AREAS**

The Department estimates the mainline surfacing width to be varied 24 to 48 feet.

The Department estimates the total mainline area to be surfaced to be 108,430 square yards.

The Department estimates the shoulder width to be 10 foot on each side.

The Department estimates the total shoulder area to be surfaced to be 53,973 square yards.

### **ASPHALT MIXTURE**

Unless otherwise noted, the Department estimates the rate of application for all asphalt mixtures to be 110 lbs/sy per inch of depth.

### **INCIDENTAL SURFACING**

The Department has included in the quantities of asphalt mixtures established in the proposal estimated quantities required for resurfacing or surfacing mailbox turnouts, farm field entrances, residential and commercial entrances, curve widening, ramp gores and tapers, and road and street approaches, as applicable. Pave these areas to the limits as shown on Standard Drawing RPM-110-06 or as directed by the Engineer. In the event signal detectors are present in the intersecting streets or roads, pave the crossroads to the right of way limit or back of the signal detector, whichever is the farthest back of the mainline. Surface or resurface these areas as directed by the Engineer. The Department will not measure placing and compacting for separate payment but shall be incidental to the Contract unit price for the asphalt mixtures.

### **FUEL AND ASPHALT PAY ADJUSTMENT**

The Department has included the Contract items Asphalt Adjustment and Fuel Adjustment for possible future payments at an established Contract unit price of \$1.00. The Department will calculate actual adjustment quantities after work is completed. If existing Contract amount is insufficient to pay all items on the contract with the adjustments, the Department will establish additional monies with a change order.

### **OPTION A**

Be advised that the Department will accept compaction of asphalt mixtures furnished for driving lanes and ramps, at 1 inch (25mm) or greater, on this project according to OPTION A in accordance with Section 402 and Section 403 of the current Standard Specifications. The Department will require joint cores as described in Section 402.03.02 for surface mixtures only. The Department will accept compaction of all other asphalt mixtures according to OPTION B.

### **MATERIAL TRANSFER VEHICLE (MTV)**

Provide and use a MTV in accordance with Sections 403.02.10 and 403.03.05.

**SPECIAL NOTE FOR NON-TRACKING TACK COAT**

1. DESCRIPTION AND USEAGE. This specification covers the requirements and practices for applying a non-tracking tack asphalt coating. Place this material on the existing pavement course, prior to placement of a new asphalt pavement layer. Use when expedited paving is necessary or when asphalt tracking would negatively impact the surrounding area. This material is not suitable for other uses. Ensure material can “break” within 15 minutes under conditions listed in 3.2.

2. MATERIALS, EQUIPMENT, AND PERSONNEL.

2.1 Non-Tracking Tack. Provide material conforming to Subsection 2.1.1.

2.1.1 Provide a tack conforming to the following material requirements:

Property	Specification	Test Procedure
Viscosity, SFS, 77 • F	20 – 100	AASHTO T 72
Sieve, %	0.3 max.	AASHTO T 59
Asphalt Residue <sup>1</sup> , %	50 min.	AASHTO T 59
Oil Distillate, %	1.0 max.	AASHTO T 59
Residue Penetration, 77 • F	20 max.	AASHTO T 49
Original Dynamic Shear (G*/sin δ), 82 • C	1.0 min.	AASHTO T 315
Softening Point, • F	149 min.	AASHTO T 53
Solubility, %	97.5 min.	AASHTO T 44

<sup>1</sup> Bring sample to 212 •F over a 10-15 minute period. Maintain 212 •F for 15-20 minutes or until 30-40 mL of water has distilled. Continue distillation as specified in T59.

2.2. Equipment. Provide a distributor truck capable of heating, circulating, and spraying the tack between 170 •F and 180 •F. Do not exceed 180 •F. Circulate the material while heating. As required by the manufacturer, ensure the spray bar is equipped with #1 or #2 ¼” V-slot Etnyre nozzles. Other nozzles are not acceptable. Arrange the nozzles in the following patterns from left to right:

Nozzle number(s)	Activity	Orientation
1	On	Vertical
2	Off	-
3	On	Horizontal
4 & 5	Off	-
6	On	Horizontal
Continue 2 off and 1 on pattern through rest of spray bar system.		

Ensure the bar can be raised to between 14 and 18” from the roadway.

2.3 Personnel. Ensure the tack supplier has provided training to the contractor on the installation procedures for this product. Make a technical representative from the supplier available at the request of the Engineer.

3. CONSTRUCTION.

3.1 Surface Preparation. Prior to the application of the non-tracking tack, ensure the pavement surface is thoroughly dry and free from dust or any other debris that would inhibit adhesion. Clean the surface by scraping, sweeping, and the use of compressed air. Ensure this preparation process occurs shortly before application to prevent the return of debris pavement. If rain is expected within one hour after application, do not apply material. Apply material only when the surface is dry, and no precipitation is expected.

3.2 Non-tracking Tack Application. Ensure the roadway temperature is a minimum of 40 °F and rising during the application of the tack. This material is not suitable for use in colder temperatures. Prior to applying the tack, demonstrate competence in applying the tack according to this note to the satisfaction of the Engineer. Heat the tack in the distributor to between 170 – 180 °F. After initial heating to between 170 – 180 °F, the material may be sprayed between 165 °F and 180 °F. Do not apply outside this temperature range. Apply material at a rate of 0.50 pounds (0.06 gallons) per square yard. Ensure full coverage of the material on the pavement surface. Full coverage of this material is critical. If full coverage is not achieved, material application rate may be increased to ensure full coverage. Do not heat material more than twice in one day.

3.3 Non-tracking Tack Certification. Furnish the tacks certification to the Engineer stating the material conforms to all requirements herein prior to use.

3.4 Sampling and Testing. The Department will require a sample of non-tracking tack be taken from the distributor at a rate of one sample per 15,000 tons of mix. Take two 1 gallon samples of the heated material and forward the sample to the Division of Materials for testing within 7 days. Ensure the product temperature is between 170 and 180 °F at the time of sampling.

4. MEASUREMENT. The Department will measure the quantity of non-tracking tack in tons. The Department will not measure for payment any extra materials, labor, methods, equipment, or construction techniques used to satisfy the requirements of this note. The Department will not measure for payment any trial applications of non-tracking tack, the cleaning of the pavement surface, or furnishing and placing the adhesive. The Department will consider all such items incidental to the non-tracking tack.

5. PAYMENT. The Department will pay for the non-tracking tack at the Contract unit bid price and apply an adjustment for each manufacturer's lot of material based on the degree of compliance as defined in the following schedule. When a sample fails on two or more tests, the Department may add the deductions, but the total deduction will not exceed 100 percent.

Non-Tracking Tack Price Adjustment Schedule						
Test	Specification	100% Pay	90% Pay	80% Pay	50% Pay	0% Pay
Viscosity, SFS, 77 • F	20 – 100	19 - 102	17 - 18	15 - 16	14	≤13
			103 - 105	106 - 107	108 - 109	≥ 110
Sieve, %	0.30 max.	• 0.40	0.41 - 0.50	0.51 - 0.60	0.61 - 0.70	≥ 0.71
Asphalt Residue, %	50 min.	• 49.0	48.5 – 48.9	48.0 – 48.4	47.5-47.9	≤ 47.4
Oil Distillate, %	1.0 max.	• 1.0	1.1-1.5	1.6 - 1.7	1.8-1.9	>2.0
Residue Penetration, 77 ° F	20 max.	• 21	22 - 23	24 - 25	26 - 27	≥ 28
Original Dynamic Shear (G*/sin δ), 82 • C	1.0 min.	• 0.95	0.92 – 0.94	0.90 – 0.91	0.85 - 0.89	≤ 0.84
Softening Point, ° F	149 min.	• 145	142 - 144	140 - 141	138 - 139	≤ 137
Solubility, %	97.5 min.	≥ 97.0	96.8 – 96.9	96.6 – 96.7	96.4 – 96.5	≤ 96.3

<u>Code</u>	<u>Pay Item</u>	<u>Pay Unit</u>
24970EC	Asphalt Material for Tack Non-Tracking	Ton

April 30, 2018

### SPECIAL NOTE FOR EDGE KEY

Construct Edge Keys at the beginning of project, end of project, at railroad crossings, and at ramps, as applicable. Unless specified in the Contract or directed by the Engineer, do not construct edge keys at intersecting streets, roads, alleys, or entrances. Cut out the existing asphalt surface to the required depth and width shown on the drawing and heel the new surface into the existing surface. The Department will make payment for this work at the Contract unit price per ton for Asphalt Pavement Milling and Texturing, which shall be full compensation for all labor, materials, equipment, and incidentals for removal and disposal of the existing asphalt surface required to construct the edge key.

### EDGE KEY

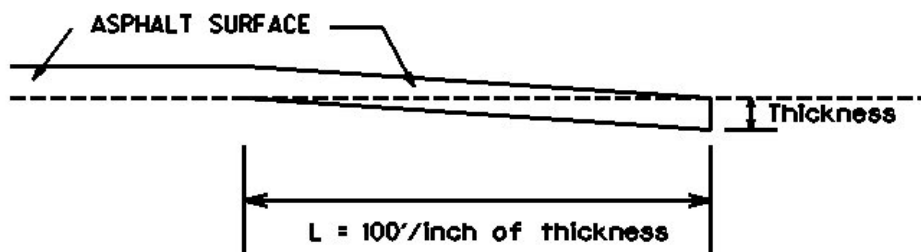

**Thickness = 1.25 Inches**

**$L = 125 LF$**

**L = Length of Edge Key**

1-3309 Edge key by Ton  
01/02//2012

**SPECIAL NOTE FOR  
ASPHALT MILLING AND TEXTURING**

Begin paving operations within **48 hours** of commencement of the milling operation. Continue paving operations continuously until completed. If paving operations are not begun within this time period, the Department will assess liquidated damages at the rate prescribed by Section 108.09 until such time as paving operations are begun.

Take possession of the millings and recycle the millings or dispose of the millings off the Right-of-Way at sites obtained by the Contractor at no additional cost to the Department.

1-3520 48 hours Contractor keeps millings  
01/2/2012

### **SPECIAL NOTE FOR TYPICAL SECTION DIMENSIONS**

Consider the dimensions shown on the typical sections for pavement and shoulder widths and thickness' to be nominal or typical dimensions. The Engineer may direct or approve varying the actual dimensions to be constructed to fit existing conditions. Do not widen existing pavement or shoulders unless specified elsewhere in this proposal or directed by the engineer.

1-3725 Typical Section Dimensions  
01/02/2012

## **TRAFFIC CONTROL PLAN**

---

### **TRAFFIC CONTROL GENERAL**

Except as provided herein, maintain and control traffic in accordance with the Standard and Supplemental Specifications and the Standard and Sepia Drawings, current editions. Except for the roadway and traffic control bid items listed, all items of work necessary to maintain and control traffic will be paid at the lump sum bid price to "Maintain and Control Traffic".

Contrary to Section 106.01, furnish new, or used in like new condition, traffic control devices at the beginning of the work and maintain in like new condition until completion of the work.

### **PROJECT PHASING & CONSTRUCTION PROCEDURES**

Do not erect lane closures during the following days and hours:

The Engineer may specify days and hours when lane closures will not be allowed.

At locations with three or more lanes, maintain one lane of traffic in each direction at all times during construction. At locations with two lanes, maintain alternating one way traffic during construction. Provide a minimum clear lane width of 11 feet; however, provide for passage of vehicles of up to 16 feet in width. If traffic should be stopped due to construction operations, and a school bus on an official run arrives on the scene, make provisions for the passage of the bus as quickly as possible.

### **LANE CLOSURES**

Do not leave lane closures in place during non-working hours.

### **SIGNS**

Sign posts and splices shall be compliant with NCHRP 350 or MASH. Manufacturer's documentation validating this compliance shall be provided to the Engineer prior to installation. Signs, including any splices, shall be installed according to manufacturer's specifications and installation recommendations. Contrary to section 112.04.02, only long-term signs (signs intended to be continuously in place for more than 3 days) will be measured for payment. Short-term signs (signs intended to be left in place for 3 days or less) will not be measured for payment but will be incidental to Maintain and Control Traffic.



Traffic Control Plan  
Page 2 of 10

### **CHANGEABLE MESSAGE SIGNS**

Provide changeable message signs in advance of and within the project at locations determined by the Engineer. If work is in progress concurrently in both directions or if more than one lane closure is in place in the same direction of travel, provide additional changeable message signs as directed by the Engineer. Place changeable message signs one mile in advance of the anticipated queue at each lane closure. As the actual queue lengthens and/or shortens, relocate or provide additional changeable message signs so that traffic has warning of slowed or stopped traffic at least one mile but not more than two miles before reaching the end of the actual queue. The Engineer may vary the designated locations as the work progresses. The Engineer will determine the messages to be displayed. In the event of damage or mechanical/electrical failure, repair or replace the Changeable Message Sign within 24 hours. The Department will measure for payment the maximum number of Changeable Message Signs in concurrent use at the same time on a single day on all sections of the contract. The Department will measure individual Changeable Message Signs only once for payment, regardless of how many times they are set, reset, removed, and relocated during the duration of the project. The Department will not measure replacements for damaged Changeable Message Signs or for signs the Engineer directs be replaced due to poor condition or readability. Retain possession of the Changeable Message Signs upon completion of the work.

### **ARROW PANELS**

Use arrow panels as shown on the Standard Drawings or as directed by the Engineer. The Department will measure for payment the maximum number of arrow panels in concurrent use at the same time on a single day on all sections of the contract. The Department will measure for payment the maximum number of Arrow Panels in concurrent use at the same time on a single day on all sections of the contract. The Department will measure individual Arrow Panels only once for payment, regardless of how many times they are set, reset, removed, and relocated during the duration of the project. The Department will not measure replacements for damaged Arrow Panels or for panels signs the Engineer directs be replaced due to poor condition or readability for payment. Retain possession of the Arrow Panels upon completion of the work.

### **TEMPORARY ENTRANCES**

The Engineer will not require the Contractor to provide continuous access to farms, single family, duplex, or triplex residential properties during working hours; however, provide reasonable egress and ingress to each such property when actual operations are not in progress at that location. Limit the time during which a farm or residential entrance is blocked to the minimum length of time required for actual operations, not extended for the Contractor's convenience, and in no case exceeding six (6) hours. Notify all residents twenty-four hours in advance of any driveway or entrance closings and make any accommodations necessary to meet the access needs of disabled residents.

Traffic Control Plan  
Page 3 of 10

Except as allowed by the Phasing as specified above, maintain direct access to all side streets and roads, schools, churches, commercial properties and apartments or apartment complexes of four or more units at all times.

The Department will measure asphalt materials required to construct and maintain any temporary entrances which may be necessary to provide temporary access; however, the Department will not measure aggregates, excavation, and/or embankment, but shall be incidental to Maintain and Control Traffic. The Engineer will determine the type of surfacing material, asphalt or aggregate, to be used at each entrance.

### **TRAFFIC SIGNAL LOOPS**

Install traffic signal loops according to the Special Notes for Traffic Signal Loop Replacement. Coordinate the placement of the loops with the Engineer.

### **THERMOPLASTIC INTERSECTION MARKINGS**

Consider the locations listed on the summary as approximate only. Prior to milling and/or resurfacing, locate and document the locations of the existing markings. After resurfacing, replace the markings at their approximate existing locations or as directed by Engineer. Place markings not existing prior to resurfacing as directed by the Engineer.

### **BARRICADES**

The Department will not measure barricades used in lieu of barrels and cones for channelization or delineation, but shall be incidental to Maintain and Control Traffic according to Section 112.04.01.

The Department will measure barricades used to protect pavement removal areas in individual units. Each. The Department will measure for payment the maximum number of barricades in concurrent use at the same time on a single day on all sections of the contract. The Department will measure individual barricades only once for payment, regardless of how many times they are set, reset, removed, and relocated during the duration of the project. The Department will not measure replacements for damaged barricades the Engineer directs to be replaced due to poor condition or reflectivity. Retain possession of the Barricades upon completion of the work.

### **PAVEMENT MARKINGS**

If there is to be a deviation from the existing striping plan, the Engineer will furnish the Contractor a striping plan prior to placement of the final surface course. Install Temporary Striping according to Section 112 with the following exceptions:

Traffic Control Plan  
Page 4 of 10

1. Include edge lines in Temporary Striping; and
2. Place Temporary or Permanent Striping before opening a lane to traffic; and
3. If the Contractor's operations or phasing requires temporary markings that must subsequently be removed from the final surface course, use an approved removable lane tape; however, the Department will not measure removable lane tape for separate payment, but will measure and pay for removable lane tape as temporary striping.

### **PAVEMENT EDGE DROP-OFFS**

Do not allow a pavement edge between opposing directions of traffic or lanes that traffic is expected to cross in a lane change situation with an elevation difference greater than 1½". Place Warning signs (MUTCD W8-11 or W8-9A) in advance of and at 1500' intervals throughout the drop-off area. Dual post the signs on both sides of the traveled way. Wedge all transverse transitions between resurfaced and unresurfaced areas which traffic may cross with asphalt mixture for leveling and wedging. Remove the wedges prior to placement of the final surface course.

Protect pavement edges that traffic is not expected to cross, except accidentally, as follows:

Less than 2" - No protection required.

2" to 4" - Place plastic drums, vertical panels, or barricades every 50 feet. During daylight working hours only, the Engineer will allow the Contractor to use cones in lieu of plastic drums, panels, and barricades. Wedge the drop-off with DGA or asphalt mixture for leveling and wedging with a 1:1 or flatter slope in daylight hours, or 3:1 or flatter slope during nighttime hours, when work is not active in the drop-off area.

Greater than 4" - Protect drop-offs greater than 4 inches within 10 feet of traffic by placing drums, vertical panels, or barricades every 25 feet. The Engineer will not allow the use of cones in lieu of drums, vertical panels, or barricades for drop-offs greater than 4". Place Type III Barricades directly in front of the drop-off facing on coming traffic in both directions of travel. Provide warning signs as shown on the Standard Drawings or as directed by the Engineer

Pedestrians & Bicycles - Protect pedestrian and bicycle traffic as directed by the engineer.

Traffic Control Plan  
Page 5 of 10

## USE AND PLACEMENT OF CHANGEABLE MESSAGE SIGNS

The following policy is based upon current Changeable Message Signs (CMS) standards and practice from many sources, including the Federal Highway Administration (FHWA), other State Departments of Transportation, and Traffic Safety Associations. It is understood that each CMS installation or use requires individual consideration due to the specific location or purpose. However, there will be elements that are constant in nearly all applications. Accordingly these recommended guidelines bring a level of uniformity, while still being open to regional experience and engineering judgment.

### Application

The primary purpose of CMS is to advise the driver of unexpected traffic and routing situations. Examples of applications where CMS can be effective include:

- Closures (road, lane, bridge, ramp, shoulder, interstate)
- Changes in alignment or surface conditions
- Significant delays, congestion
- Construction/maintenance activities (delays, future activities)
- Detours/alternative routes
- Special events with traffic and safety implications
- Crash/incidents
- Vehicle restrictions (width, height, weight, flammable)
- Advance notice of new traffic control devices
- Real-time traffic conditions (must be kept up to date)
- Weather /driving conditions, environmental conditions, Roadway Weather Information Systems
- Emergency Situations
- Referral to Highway Advisory Radio (if available)
- Messages as approved by the County Engineer's Office

### **CMS should not be used for:**

- Replacement of static signs (e.g. road work ahead), regulatory signage (e.g. speed limits), pavement markings, standard traffic control devices, conventional warning or guide signs.
- Replacement of lighted arrow board
- Advertising (Don't advertise the event unless clarifying "action" to be taken by driver – e.g. Speedway traffic next exit)
- Generic messages
- Test messages (portable signs only)
- Describe recurrent congestion (e.g. rush hour)
- Public service announcements (not traffic related)

Traffic Control Plan  
Page 6 of 10

**Messages**

Basic principles that are important to providing proper messages and insuring the proper operation of a CMS are:

- Visible for at least ½ mile under ideal daytime and nighttime conditions
- Legible from all lanes a minimum of 650 feet
- Entire message readable twice while traveling at the posted speed
- Nor more than two message panels should be used (three panels may be used on roadways where vehicles are traveling less than 45 mph). A panel is the message that fits on the face of the sign without flipping or scrolling.
- Each panel should convey a single thought; short and concise
- Do not use two unrelated panels on a sign
- Do not use the sign for two unrelated messages
- Should not scroll text horizontally or vertically
- Should not contain both the words left and right
- Use standardized abbreviations and messages
- Should be accurate and timely
- Avoid filler/unnecessary words and periods (hazardous, a, an, the)
- Avoid use of speed limits
- Use words (not numbers) for dates

**Placement**

Placement of the CMS is important to insure that the signs is visible to the driver and provides ample time to take any necessary action. Some of the following principles may only be applicable to controlled access roadways. The basic principles of placement for a CMS are:

- When 2 signs are needed, place on same side of roadway and at least 1,000 feet apart
- Place behind semi-rigid/rigid protection (guardrail, barrier) or outside of the clear zone
- Place 1,000 feet in advance of work zone; at least one mile ahead of decision point
- Normally place on right side of roadway; but should be placed closest to the affected lane so that either side is acceptable
- Signs should not be dual mounted (one on each side of roadway facing same direction)
- Point trailer hitch downstream
- Secure to immovable object to prevent thief (if necessary)
- Do not place in sags or just beyond crest
- Check for reflection of sun to prevent the blinding of motorist
- Should be turned ~3 degrees outward from perpendicular to the edge of pavement
- Bottom of sign should be 7 feet above the elevation of edge of roadway
- Should be removed when not in use
-

Traffic Control Plan  
 Page 7 of 10

**Standard Abbreviations**

The following is a list of standard abbreviations to be used on CMS.

<u>Word</u>	<u>Abbrev.</u>	<u>Example</u>
Access	ACCS	ACCIDENT AHEAD/USE ACCS RD NEXT RIGHT
Alternate	ALT	ACCIDENT AHEAD/USE ALT RTE NEXT RIGHT
Avenue	AVE	FIFTH AVE CLOSED/DETOUR NEXT LEFT
Blocked	BLKD	FIFTH AVE BLKD/MERGE LEFT
Boulevard	BLVD	MAIN BLVD CLOSED/USE ALT RTE
Bridge	BRDG	SMITH BRDG CLOSED/USE ALT RTE
Cardinal Directions	N, S, E, W	N I75 CLOSED/ DETOUR EXIT 30
Center	CNTR	CNTR LANE CLOSED/MERGE LEFT
Commercial	COMM	OVRSZ COMM VEH/USE I275
Condition	COND	ICY COND POSSIBLE
Congested	CONG	HVY CONG NEXT 3 MI
Construction	CONST	CONST WORK AHEAD/EXPECT DELAYS
Downtown	DWNTN	DWNTN TRAF USE EX 40
Eastbound	E-BND	E-BND I64 CLOSED/DETOUR EXIT 20
Emergency	EMER	EMER VEH AHEAD/PREPARE TO STOP
Entrance, Enter	EX, EXT	DWNTN TRAF USE EX 40
Expressway	EXPWY	WTRSN EXPWY CLOSED/DETOUR EXIT 10
Freeway	FRWY, FWY	GN SYNDR FWY CLOSED/DETOUR EXIT 15
Hazardous Materials	HAZMAT	HAZMAT IN ROADWAY/ALL TRAF EXIT 25
Highway	HWY	ACCIDENT ON AA HWY/EXPECT DELAYS
Hour	HR	ACCIDENT ON AA HWY/2 HR DELAY
Information	INFO	TRAF INFO TUNE TO 1240 AM
Interstate	I	E-BND I64 CLOSED/DETOUR EXIT 20
Lane	LN	LN CLOSED/MERGE LEFT
Left	LFT	LANE CLOSED/MERGE LFT
Local	LOC	LOC TRAF USE ALT RTE
Maintenance	MAINT	MAINT WRK ON BRDG/SLOW
Major	MAJ	MAJ DELWAYS I75/USE ALT RTE

Traffic Control Plan  
 Page 8 of 10

Mile	MI	ACCIDENT 3 MI AHEAD/ USE ALT RTE
Minor	MNR	ACCIDENT 3 MI MNR DELAY
Minutes	MIN	ACCIDENT 3 MI/30 MIN DELAY
Northbound	N-BND	N-BND I75 CLOSED/ DETOUR EXIT 50
Oversized	OVRSZ	OVRSZ COMM VEH/USE I275 NEXT RIGHT
Parking	PKING	EVENT PKING NEXT RGT
Parkway	PKWY	CUM PKWAY TRAF/DETOUR EXIT 60
Prepare	PREP	ACCIDENT 3 MIL/PREP TO STOP
Right	RGT	EVENT PKING NEXT RGT
Road	RD	HAZMAT IN RD/ALL TRAF EXIT 25
Roadwork	RDWK	RDWK NEXT 4 MI/POSSIBLE DELAYS
Route	RTE	MAJ DELAYS I75/USE ALT RTE
Shoulder	SHLDR	SHLDR CLOSED NEXT 5 MI
Slippery	SLIP	SLIP COND POSSIBLE/ SLOW SPD
Southbound	S-BND	S-BND I75 CLOSED/DETOUR EXIT 50
Speed	SPD	SLIP COND POSSIBLE/ SLOW SPD
Street	ST	MAIN ST CLOSED/USE ALT RTE
Traffic	TRAF	CUM PKWAY TRAF/DETOUR EXIT 60
Vehicle	VEH	OVRSZ COMM VEH/USE I275 NEXT RIGHT
Westbound	W-BND	W-BND I64 CLOSED/DETOUR EXIT 50
Work	WRK	CONST WRK 2MI/POSSIBLE DELAYS

Certain abbreviations are prone to inviting confusion because another word is abbreviated or could be abbreviated in the same way. DO NO USE THESE ABBREVIATIONS.

<u>Abbrev.</u>	<u>Intended Word</u>	<u>Word Erroneously Given</u>
ACC	Accident	Access (Road)
CLRS	Clears	Colors
DLY	Delay	Daily
FDR	Feeder	Federal
L	Left	Lane (merge)
LOC	Local	Location
LT	Light (traffic)	Left
PARK	Parking	Park
POLL	Pollution (index)	Poll
RED	Reduce	Red
STAD	Stadium	Standard

Traffic Control Plan  
 Page 9 of 10

TEMP  
 WRNG

Temporary  
 Warning

Temperature  
 Wrong

**TYPICAL MESSAGES**

The following is a list of typical messages used on CMS. The list consists of the reason or problem that you want the driver to be aware of and the action that you want the driver to take.

**Reason/Problem**

ACCIDENT  
 ACCIDENT/XX MILES  
 XX ROAD CLOSED  
 XX EXIT CLOSED  
 BRIDGE CLOSED  
 BRIDGE/(SLIPPERY, ICE, ETC.)  
 CENTER/LANE/CLOSED  
 DELAY(S), MAJOR/DELAYS  
 DEBRIS AHEAD  
 DENSE FOG  
 DISABLED/VEHICLE  
 EMER/VEHICLES/ONLY  
 EVENT PARKING  
 EXIT XX CLOSED  
 FLAGGER XX MILES  
 FOG XX MILES  
 FREEWAY CLOSED  
 FRESH OIL  
 HAZMAT SPILL  
 ICE  
 INCIDENT AHEAD  
 LANES (NARROW, SHIFT, MERGE, ETC.)  
 LEFT LANE CLOSED  
 LEFT LANE NARROWS  
 LEFT 2 LANES CLOSED  
 LEFT SHOULDER CLOSED  
 LOOSE GRAVEL  
 MEDIAN WORK XX MILES  
 MOVING WORK ZONE, WORKERS IN ROADWAY  
 NEXT EXIT CLOSED  
 NO OVERSIZED LOADS  
 NO PASSING  
 NO SHOULDER  
 ONE LANE BRIDGE

**Action**

ALL TRAFFIC EXIT RT  
 AVOID DELAY USE XX  
 CONSIDER ALT ROUTE  
 DETOUR  
 DETOUR XX MILES  
 DO NOT PASS  
 EXPECT DELAYS  
 FOLLOW ALT ROUTE  
 KEEP LEFT  
 KEEP RIGHT  
 MERGE XX MILES  
 MERGE LEFT  
 MERGE RIGHT  
 ONE-WAY TRAFFIC  
 PASS TO LEFT  
 PASS TO RIGHT  
 PREPARE TO STOP  
 REDUCE SPEED  
 SLOW  
 SLOW DOWN  
 STAY IN LANE  
 STOP AHEAD  
 STOP XX MILES  
 TUNE RADIO 1610 AM  
 USE NN ROAD  
 USE CENTER LANE  
 USE DETOUR ROUTE  
 USE LEFT TURN LANE  
 USE NEXT EXIT  
 USE RIGHT LANE  
 WATCH FOR FLAGGER



Traffic Control Plan  
Page 10 of 10

PEOPLE CROSSING  
RAMP CLOSED  
RAMP (SLIPPERY, ICE, ETC.)  
RIGHT LANE CLOSED  
RIGHT LANE NARROWS  
RIGHT SHOULDER CLOSED  
ROAD CLOSED  
ROAD CLOSED XX MILES  
ROAD (SLIPPERY, ICE, ETC.)  
ROAD WORK  
ROAD WORK (OR CONSTRUCTION) (TONIGHT, TODAY, TOMORROW, DATE)  
ROAD WORK XX MILES  
SHOULDER (SLIPPERY, ICE, SOFT, BLOCKED, ETC.)  
NEW SIGNAL XX MILES  
SLOW 1 (OR 2) - WAY TRAFFIC  
SOFT SHOULDER  
STALLED VEHICLES AHEAD  
TRAFFIC BACKUP  
TRAFFIC SLOWS  
TRUCK CROSSING  
TRUCKS ENTERING  
TOW TRUCK AHEAD  
UNEVEN LANES  
WATER ON ROAD  
WET PAINT  
WORK ZONE XX MILES  
WORKERS AHEAD

DURABLE PAVEMENT EDGE DETAIL

(Resurfacing adjacent to fill slope or ditch foreslope that is 3:1 or less)



DURABLE PAVEMENT EDGE DETAIL

(Resurfacing adjacent to fill slope or ditch foreslope that is steeper than 3:1)

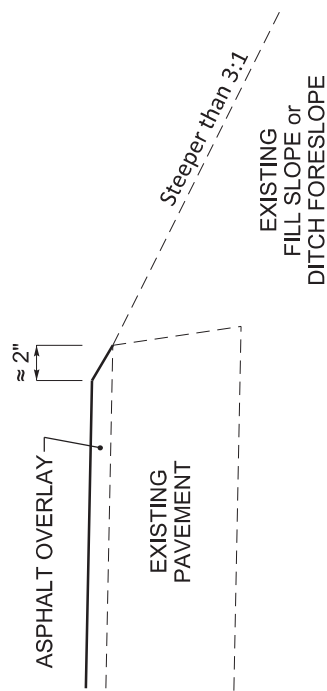

DURABLE PAVEMENT EDGE DETAIL

(Resurfacing adjacent to low shoulder with dropoff of 5 inches or less)

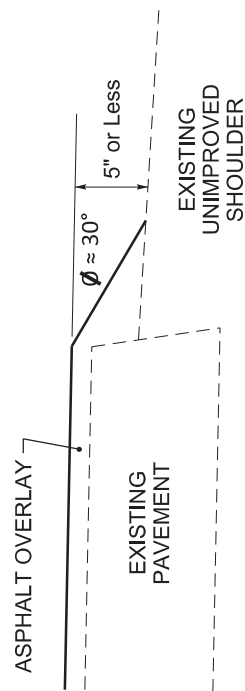

DURABLE PAVEMENT EDGE DETAIL

(Resurfacing adjacent to low shoulder with dropoff of more than 5 inches)

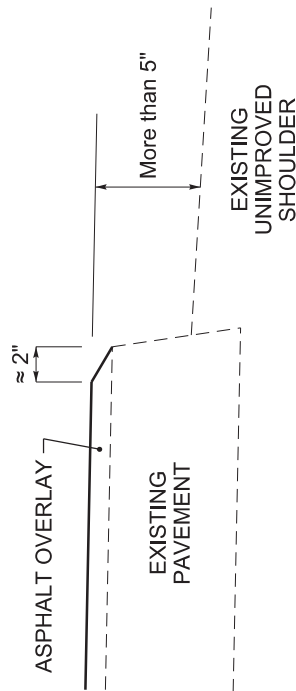

DURABLE PAVEMENT EDGE DETAIL

(Resurfacing adjacent to an obstruction, such as an existing headwall)

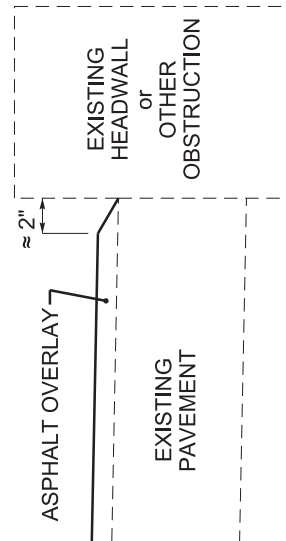

NOTES

1. DETAILS DO NOT APPLY TO OVERLAYS LESS THAN 1 INCH THICK.
2. THE DURABLE PAVEMENT EDGE DEVICE MAY BE DISENGAGED AT DRIVEWAYS, SIDE STREETS, HIGH SHOULDERS, AND OTHER LOCATIONS NOT FEASIBLE TO CONSTRUCT, AS APPROVED BY THE ENGINEER.

DRAWING NOT TO SCALE

DURABLE PAVEMENT EDGE  
DETAILS

## SPECIAL NOTE FOR TRAFFIC SIGNAL LOOP DETECTORS

**1.0 DESCRIPTION.** Be advised that there are existing traffic signal loop detectors within the construction limits of this project. Except as specified herein, perform traffic signal loop replacement in accordance with the Department's Standard/Supplemental Specifications, Special Provisions, Special Notes, and Standard/Sepia Drawings, current editions and as directed by the Engineer. Article references are to the Standard Specifications. Furnish all materials, labor, equipment, and incidentals for replacement of traffic signal loop installation(s) and all other work specified as part of this contract.

**1.1 Pre-bid Requirements.** Each Contractor submitting a bid for this work shall make a thorough inspection of the site prior to submitting his bid and shall thoroughly familiarize himself with existing conditions so that the work can be expeditiously performed after a Contract is awarded. Information provided in the Plans regarding types and quantities of work is not to be taken as an accurate or complete evaluation of the materials and conditions to be encountered during construction. The bidder must make his own determinations as to the conditions encountered.

**2.0 MATERIALS.** Except as specified herein, furnish materials in accordance with Subsection 732.02 and Section 835. Provide for materials to be sampled and tested in accordance with the Department's Sampling Manual. Make materials available for sampling a sufficient time in advance of the use of the materials to allow for the necessary time for testing, unless otherwise specified in this Special Note.

**2.1 Maintain and Control Traffic.** See Traffic Control Plan.

**2.2 Sand.** Furnish natural sand meeting the requirements of Subsection 804.04.01.

**2.3 Seeding.** Furnish Seed Mix Type I.

**2.4 Loop Saw Slot and Fill.** Furnish loop sealant, backer rod, and non-shrink grout according to the Saw Slot Detail.

**2.5 Junction Boxes.** Furnish junction box type B, #57 aggregate, and geotextile filter type IV according to junction box detail.

**2.6 Cable No. 14/1 Pair (Lead-in).** Furnish cable that is specified in Section 835. Cable shall be ran splice free. This shall include splice kits to connect to the loop wire.

**2.7 Conduit.** Furnish and install appropriate conduit from transitions to the roadway, junction boxes and poles. See details below.

**3.0 CONSTRUCTION.** Except as specified herein, install and test Traffic Signal Loop Detectors in accordance with Section 723 and the drawings.

**3.1 Testing.** The Contractor shall test all loops and cable no. 14/1 pair (lead-in) according to Subsection 723.03.17 before and after milling the roadway. The Contractor may have to separate the loop from the lead-in to perform this test. If the loop/lead-in meets the requirement in Section 723 at the controller cabinet, the loop/lead-in shall not be replaced. If existing loops do not meet the requirements in Subsection 723.03.17, the loops shall be replaced. Replacement loops may be installed either before or after the milling process.

## Traffic Signal Loop Detectors

### Page 2 of 8

The Contractor shall verify that loops (both existing and replacement loops) meet the requirements per Subsection 723.03.17 before the final surface is laid. If loops do not meet conditions of Subsection 723.03.17, the Contractor shall replace them before the resurfacing activities begin. If replacement loops have to be reinstalled, the costs of reinstallation shall be incidental to the milling bid item. The Contractor shall re-splice loops to the lead-in with the proper splice as noted in the spec book.

**3.2 Coordination.** Notify the Engineer in writing, two (2) weeks prior to beginning any work. The Engineer will contact the District Traffic Engineer to coordinate the Department's operations with the Contractor's work.

**3.3 Connection.** The Contractor shall schedule all signal loop installation to ensure the new loops are connected to the lead-in and operational within 5 calendar days of the old loops being damaged and/or disconnected. This requirement includes damage caused by any work activity associated with the project. If the new signal loops are not functioning as intended following 5 calendar days, the Department may assess Liquidated Damages at a rate of \$500 per calendar day per signal location until the loops are operating at pre-construction conditions. All liquidated damages will be applied cumulatively.

**3.4 Maintain and Control Traffic.** See Traffic Control Plan.

**3.5 Milling.** On projects involving milling and texturing of the existing pavement, install loops in the existing pavement before or after performing the milling and texturing. After milling, the remnant contents of the existing saw slot (grout, loop wires, backer rod, and/or loop sealant) may not be flush with the top of the milled portion of the surface. In such cases, clear the saw slot of loose remnant contents and refill the saw slot with natural sand. Obtain the Engineer's approval of the stabilized saw slot prior to resurfacing. The Department will not measure for separate payment clearing and stabilizing the saw slot and shall consider this work incidental to milling.

**3.6 Loop Saw Slot and Fill.** The following is a typical step by step procedure for the installation of a loop.

- 1) Carefully mark the slot to be cut, perpendicular to the flow of traffic and centered in the lane.
- 2) Make each saw-cut 3/8-inch wide and at a depth such that the top of the backer rod is a minimum of 4 inches below the surface of asphalt pavement.
- 3) Drill a 1½ inch core hole at each corner and use a chisel to smooth corners to prevent sharp bends in the wire.
- 4) Clean all foreign and loose matter out of the slots and drilled cores and within 1 foot on all sides of the slots using a high pressure washer.
- 5) Completely dry the slots and drilled cores and within 1 foot on all sides of the slots.
- 6) Measure 9-12 inches from the edge of the paved surface (shoulder break or face of curb) and drill a 1½ inch hole on a 45° angle to the conduit adjacent to the roadway.
- 7) Closely inspect all cuts, cores, and slots for jagged edges or protrusions prior to the placement of the wire. All jagged edges and protrusions shall be ground or re-cut and cleaned again.

## Traffic Signal Loop Detectors

### Page 3 of 8

- 8) Place the loop wire splice-free from the termination point (cabinet or junction box) to the loop, continue around the loop for two turns (6'x30' loop) or three turns (6'x6' loop), and return to the termination point.
- 9) Push the wire into the saw slot with a blunt object such as a wooden stick. Make sure that the loop wire is pushed fully to the bottom of the saw slot. Screwdrivers shall not be used.
- 10) Install duct sealant to a minimum of 1 inch deep into the cored 1½ inch hole.
- 11) Apply loop sealant from the bottom up and fully encapsulate the loop wires in the saw slot. The wire should not be able to move when the sealant has set.
- 12) Cover the encapsulated loop wire with a continuous layer of backer rod along the entire loop and home run saw slots such that no voids are present between the loop sealant and backer rod.
- 13) Finish filling the saw cut with non-shrinkable grout per manufacturer's instructions. Alleviate all air pockets and refill low spaces. There shall be no concave portion to the grout in the saw slot. Any excess grout shall be cleaned from the roadway to alleviate tracking.
- 14) Clean up the site and dispose of all waste off the project.
- 15) Ensure that the grout has completely cured prior to subjecting the loop to traffic. Curing time varies with temperature and humidity.

**3.7 Final Dressing, Clean Up, and Seeding.** After all work is completed, clean work sites and all disturbed areas. Dispose of all waste and debris off the right of way at sites obtained by the Contractor at no additional cost to the Department. Sow all disturbed earthen areas with Seed Mix Type I.

**3.8 Removal.** The Contractor shall remove all existing junction boxes, wire from spans/poles/junction boxes/conduits, and conduits. The removal will be incidental to the project.

**3.9 Property/Roadway Damage.** The Contractor shall be responsible for all damage to public and/or private property resulting from the work. Upon completion of the work, restore all disturbed highway features and private property in like kind design and materials at no additional cost to the Department.

**3.10 Right-of-Way Limits.** The Department has not established exact limits of Right-of-Way. Limit work activities to obvious Right-of-Way and work areas secured by the Department through Consent and Release of the adjacent property owners. Contractor is responsible for all encroachments onto private lands.

**3.11 Utility Clearance.** Work around and do not disturb existing utilities. The Department does not anticipate any utility impacts for loop installation. If utilities are impacted, work with associated utility companies to resolve issues.

**3.12 Control.** Obtain the Engineer's approval of all designs required to be furnished by the Contractor prior to incorporation into the work. The Department reserves the right to permit other contractors, state forces, public utility companies, and others to do work during the construction within the limits of, or adjacent to, the project. Conduct operations and cooperate with such other parties so that interference with each other's work will be reduced to a minimum. The Contractor agrees to make no claims against the Department for additional compensation due to delays or other conditions created by

Traffic Signal Loop Detectors  
 Page 4 of 8

the operations of such other parties. Should a difference of opinion arise as to the rights of the Contractor and others working within the limits of, or adjacent to, the project, the Engineer will decide as to the respective rights of the various parties involved in order to ensure the completion of the work in general harmony and in a satisfactory manner, and the Engineer's decision shall be final and binding upon the Contractor.

**3.13 Bore and Jack.** Except for situations outlined in 3.15, bore and jack will be used if conduit is under pavement of any kind. The conduit shall be 2" rigid steel conduit under all pavement areas except for the area where the loop transitions from the saw slot. The installation of conduit should follow the below detail.

**3.14 Open Cut Roadway.** With permission of the Engineer, roadway may be open cut if the conduit is under pavement. The conduit shall be 2" rigid steel conduit under all pavement areas except for the area that the loop transition from the saw slot. The installation of conduit should follow requirements per Section 723.

**4.0 MEASUREMENT.** See Subsection 723.04 for bid item notes. Additional bid items include the following:

**4.1 Loop Test.** The Department will measure the quantity as each individual unit loop tested. The Department will not measure disconnection, reconnection, traffic control, re-splicing per specifications, before and after testing per note above, and any associated hardware for payment and will consider them incidental to this item of work.

**5.0 PAYMENT.** The Department will make payment for the completed and accepted quantities of listed items according to Subsection 723.05 in addition to the following:

<u>Code</u>	<u>Pay Item</u>	<u>Pay Unit</u>
Conduit 1"	4792	Linear Foot
PVC Conduit – 1 ¼ inch – sch 80	24900EC	Linear Foot
PVC Conduit – 2 inch – sch 80	24901EC	Linear Foot
Conduit 2"	4795	Linear Foot
Electrical Junction Box type B	4811	Each
Loop Test	24963ED	Each
Trenching and Backfilling	4820	Linear Foot
Loop Wire	4830	Linear Foot
Cable-No. 14/1 Pair	4850	Linear Foot <sup>1</sup>
Loop Saw Slot and Fill	4895	Linear Foot <sup>1</sup>
Bore and Jack Conduit	21543EN	Linear Foot <sup>3</sup>
Open Cut Roadway	4821	Linear Foot <sup>3</sup>

The Department will consider payment as full compensation for all work required under these notes and the Standard Specifications.

# Traffic Signal Loop Detectors

Page 5 of 8

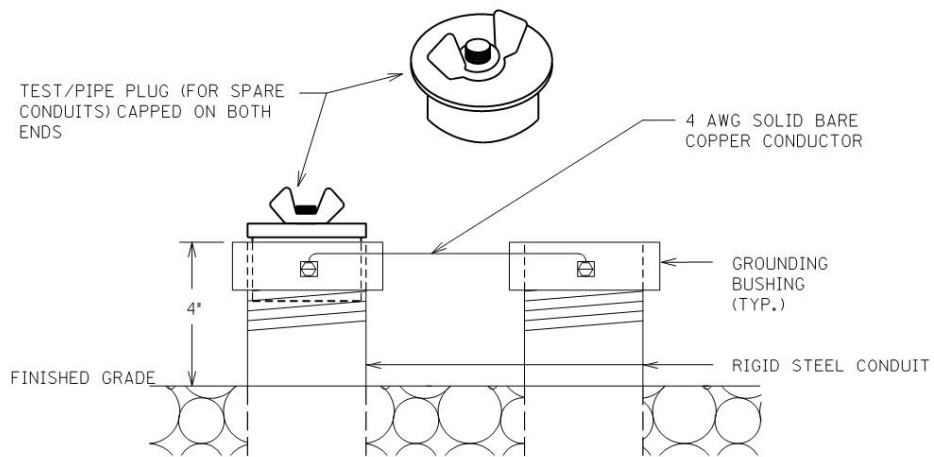

TEST/PIPE PLUG(FOR SPARE CONDUITS) AND GROUNDING DETAIL

Traffic Signal Loop Detectors  
Page 6 of 8

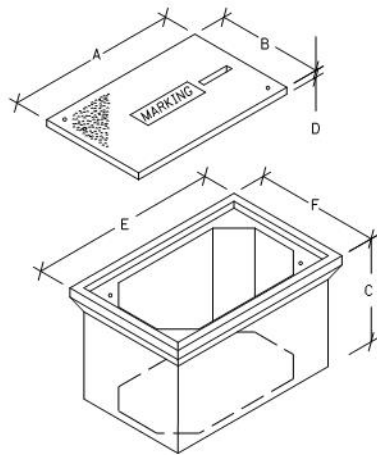

JUNCTION BOX DIMENSIONS (NOMINAL)						
	A	B	C	D	E	F
TYPE A	23"	14"	27"	2"	25"	15"
TYPE B	18"	11"	12"	1 3/4"	20"	13"
TYPE C	36"	24"	30"	3"	38"	26"

• MINIMUM  
NOTE: STACKABLE BOXES ARE PERMITTED

BEFORE THE INSTALLATION OF THE #57 AGGREGATE AND JUNCTION BOX, THE CONTRACTOR SHALL INSTALL GEOTEXTILE FILTER FABRIC TYPE IV IN THE HOLE. THE FABRIC SHALL EXTEND TO JUST BELOW THE LIP OF THE JUNCTION BOX AND SHALL BE CONTINUOUSLY ADHERED TO THE EXTERIOR OF THE BOX WITH ADHESIVE. ANY LOCATIONS WHERE CONDUITS ENTER THE BOX, THE FABRIC SHALL BE 'X CUT' ONLY AS MUCH AS NECESSARY TO ALLOW PASSAGE OF EACH INDIVIDUAL CONDUIT THROUGH THE FABRIC. THE FABRIC SHALL BE INCIDENTAL TO BID ITEMS 481I, 2039INS835, OR 20392NS835.

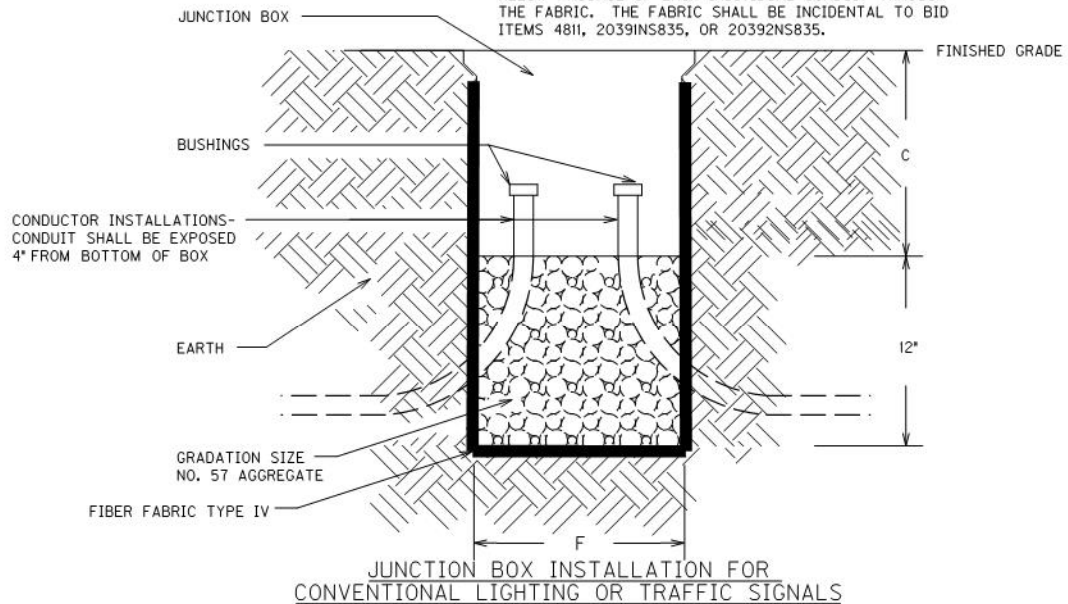

JUNCTION BOX INSTALLATION FOR CONVENTIONAL LIGHTING OR TRAFFIC SIGNALS

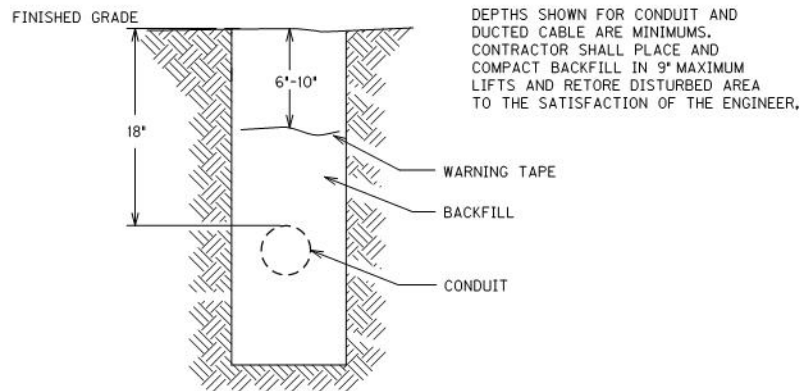

CONDUIT AND WARNING TAPE TRENCH



# Traffic Signal Loop Detectors

## Page 7 of 8

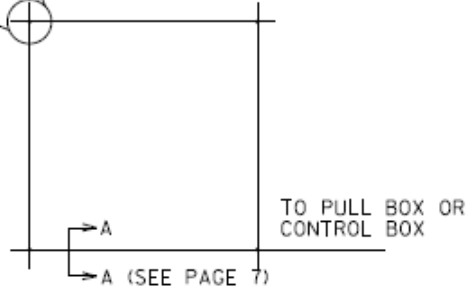
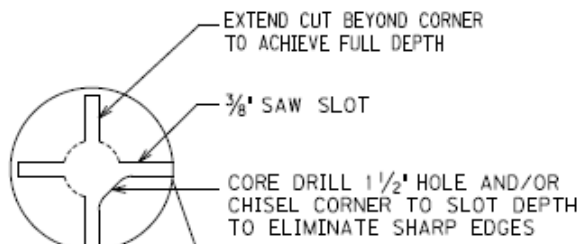

SAW CUT PLAN

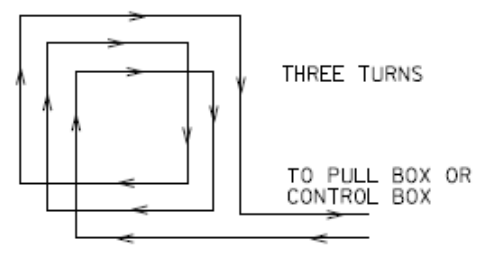

WIRING PLAN

6'X6' LOOP

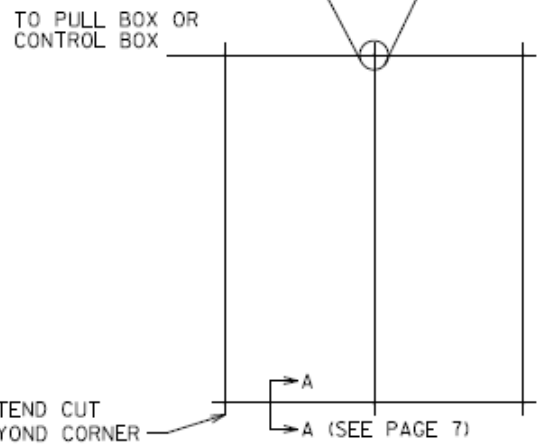
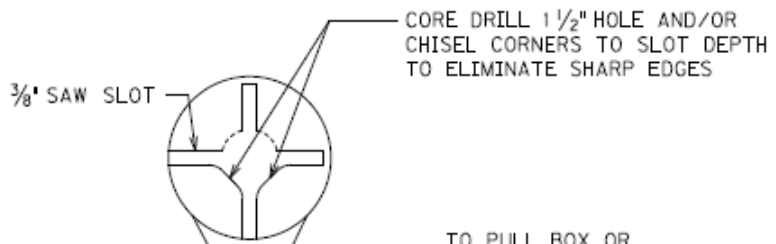

SAW CUT PLAN

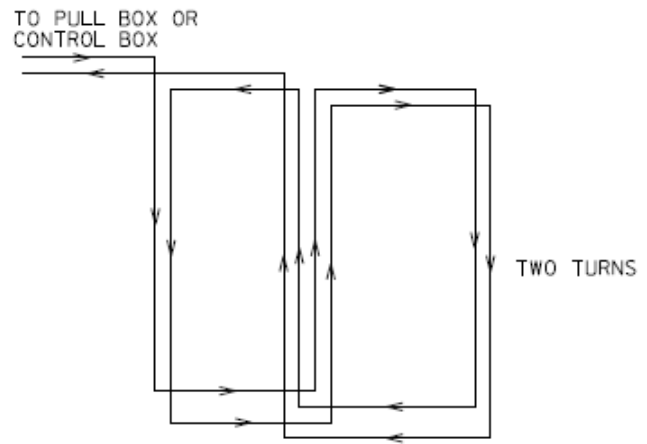

WIRING PLAN

6'X30' QUADRAPOLE LOOP

# Traffic Signal Loop Detectors

Page 8 of 8

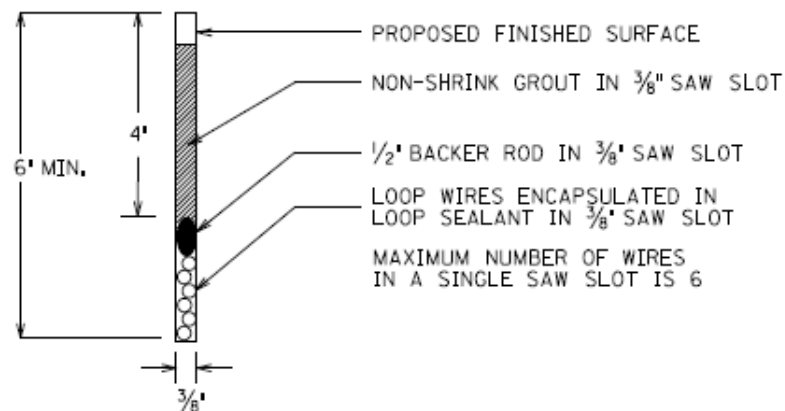

SECTION A-A (SAW SLOT DETAIL)

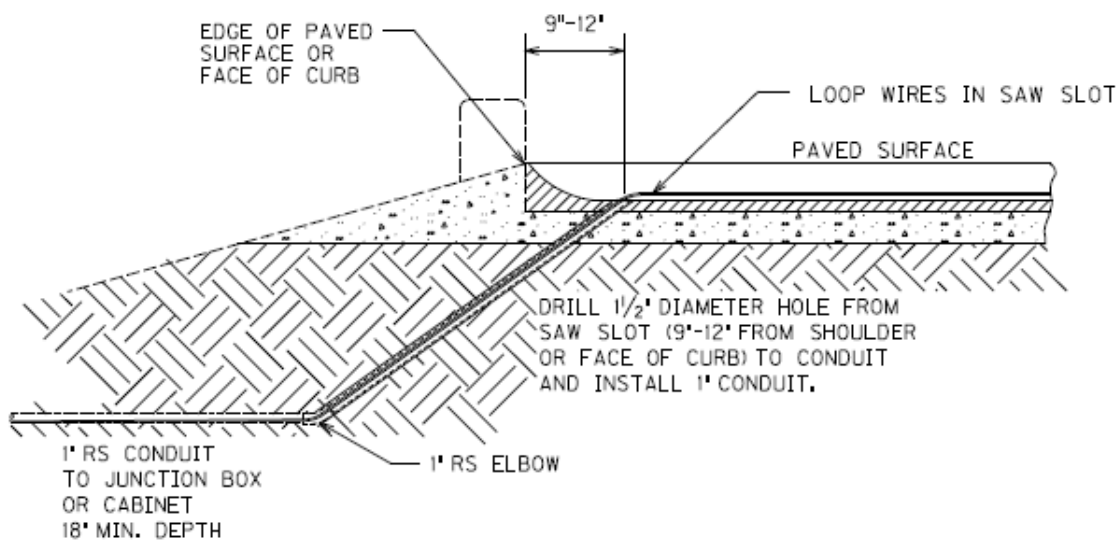

SAW SLOT EDGE OF PAVEMENT TRANSITION

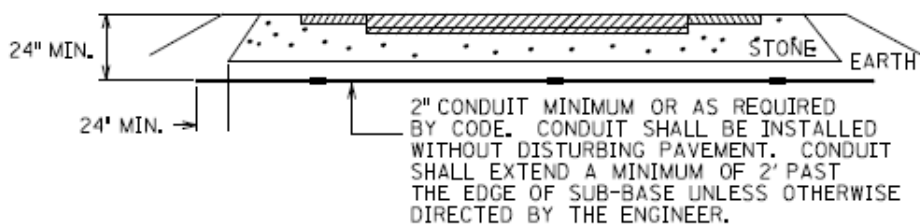

CONDUIT UNDER EXISTING PAVEMENT DETAIL

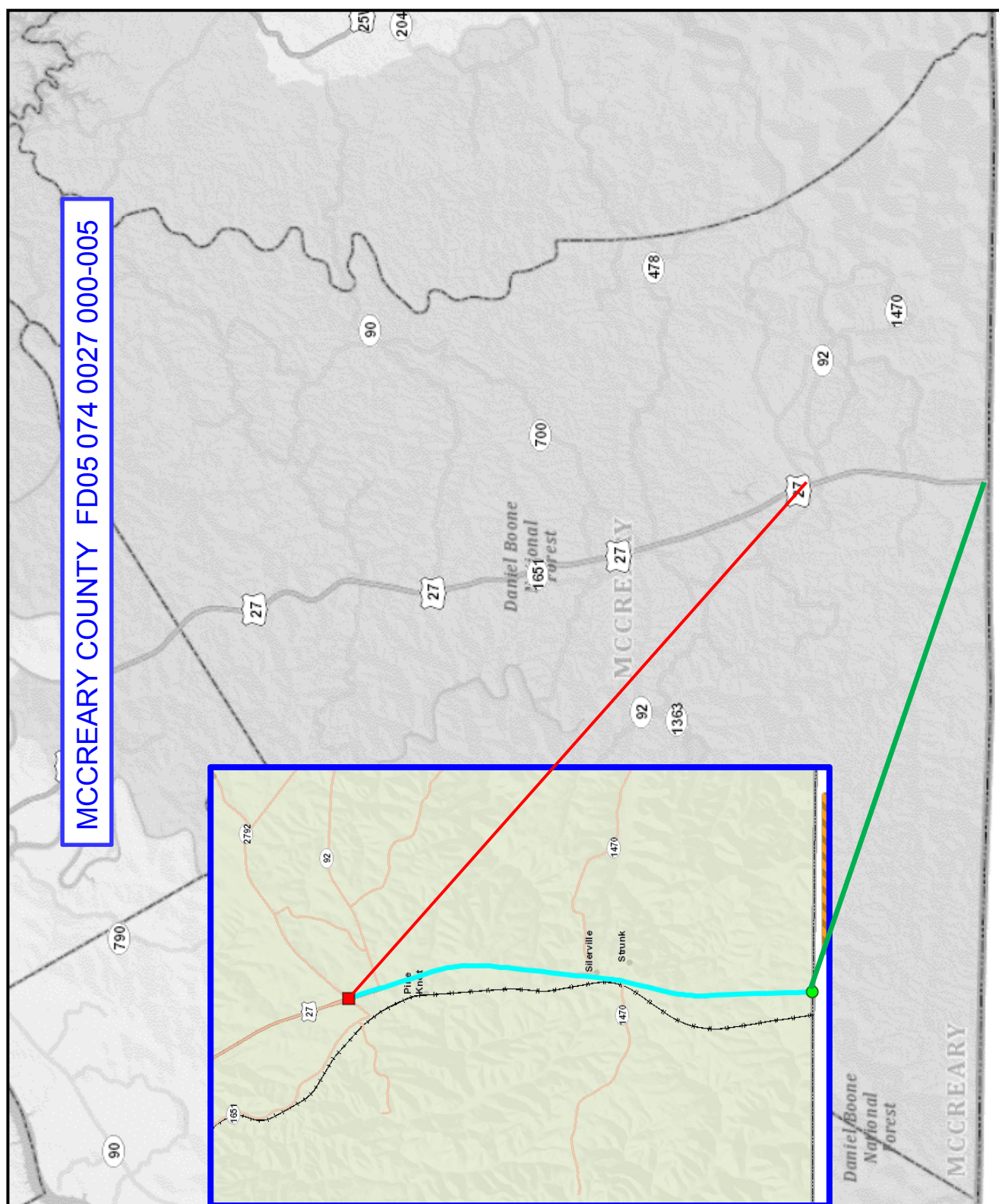

MCCRERY COUNTY FD05 074 0027 000-005

**McCreary County**  
**TRAFFIC LOOP SUMMARY**  
**FD05-074-0027-000-005**  
**LOOP SUMMARY**

MPT.	INTERSECTION	SAW SLOT AND FILL		LOOP WIRE		CONDUIT 1 INCH		CONDUIT 1 1/4 INCH		CONDUIT 1 1/2 INCH		CONDUIT 2 INCH		CABLE NO. 14		LOOP TEST		JUNCTION BOX		TRENCHING AND BACKFILLING		NOTES
		LF		LF		RS	LF	RS	LF	RS	LF	RS	LF	EA	EA	EA	EA	EA	EA	EA		
4.608	US 27 @ KY 2792 & KY 1651																					
	South Leg	348		872		60		280		210		60		3300		3		3		3	600	(1) 6 ft x 30 ft Loop @ Stop Bar in Left Turn Lane, (2) 6 ft x 6 ft Loops 201 ft from Stop Bar in Thru Lanes, (2) 6 ft x 6 ft Loops 352 ft from Stop Bar in Thru Lanes.
<b>TOTAL</b>		<b>348</b>		<b>872</b>		<b>60</b>		<b>280</b>		<b>210</b>		<b>60</b>		<b>3300</b>		<b>3</b>		<b>3</b>		<b>3</b>	<b>600</b>	

**NOTES:**  
1. Quantities are for estimating purposes only. The Contractor shall field measure items to verify quantities.  
2. All loops shall feed into 1" rigid steel conduit as per standard detail





**MCCREARY COUNTY**  
**FD05 074-0027-000-005**  
**TYPICAL SECTION (2 to 4 lane Section NO MEDIAN)**  
**MP 0.00 TO MP 4.23**

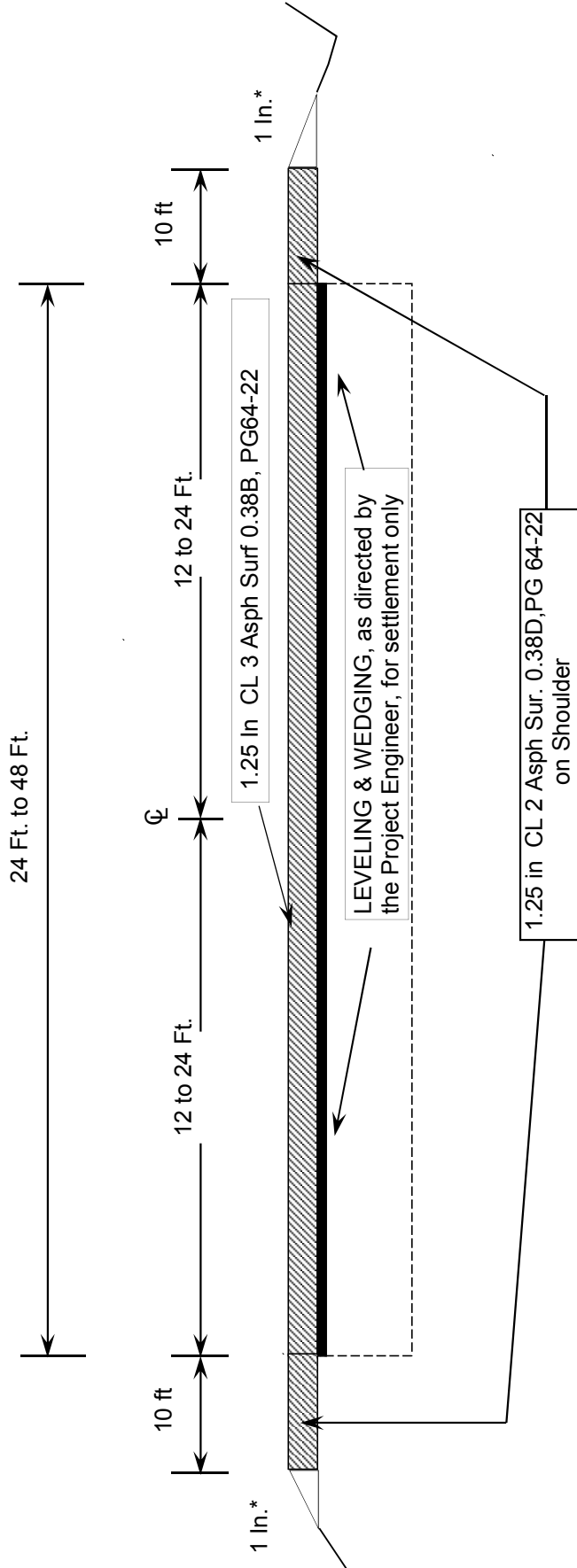

\*Where Existing Site Conditions Permit

**MCCREARY COUNTY**  
**FD05 074-0027-000-005**  
**TYPICAL SECTION (4 lane Section WITH MEDIAN)**  
**MP 4.230 TO MP 4.608**

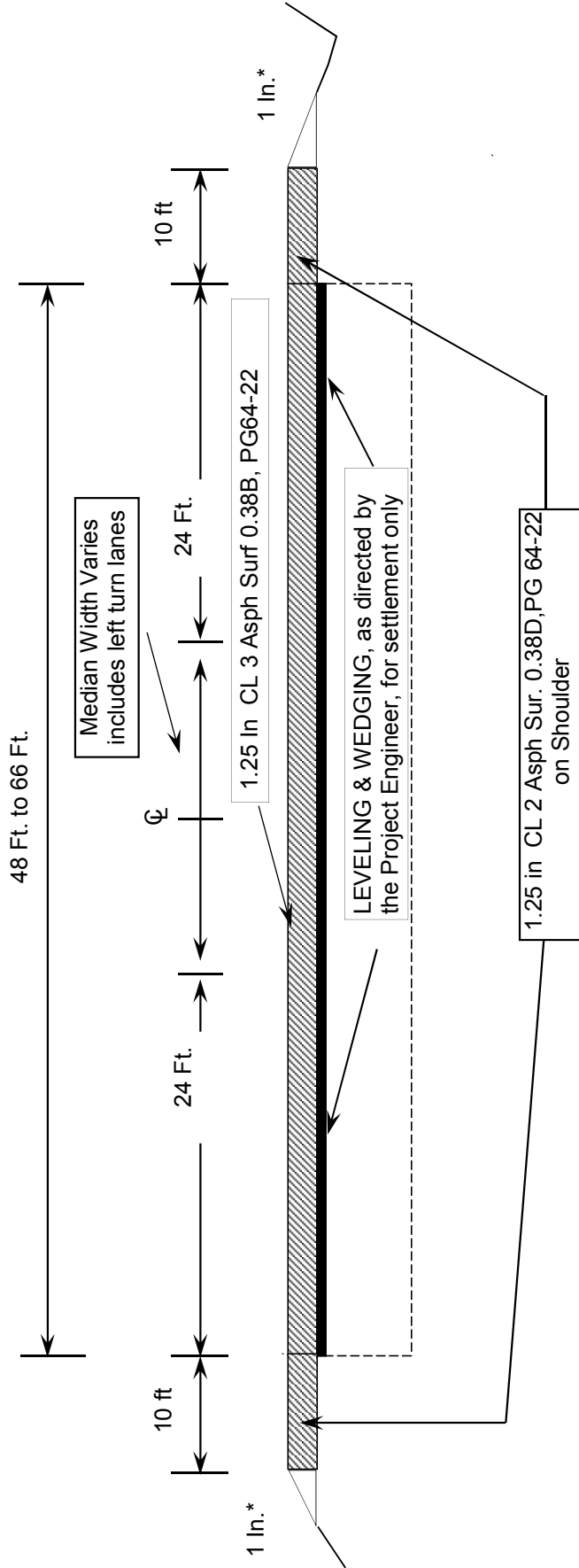

\*Where Existing Site Conditions Permit



**PART II**  
**SPECIFICATIONS AND STANDARD DRAWINGS**

### **SPECIFICATIONS REFERENCE**

Any reference in the plans or proposal to previous editions of the *Standard Specifications for Road and Bridge Construction* and *Standard Drawings* are superseded by *Standard Specifications for Road and Bridge Construction, Edition of 2012* and *Standard Drawings, Edition of 2016*.

## **SUPPLEMENTAL SPECIFICATIONS**

The contractor shall use the Supplemental Specifications that are effective at the time of letting.  
The Supplemental Specifications can be found at the following link:

<http://transportation.ky.gov/Construction/Pages/Kentucky-Standard-Specifications.aspx>

### **SPECIAL NOTE FOR PORTABLE CHANGEABLE MESSAGE SIGNS**

This Special Note will apply when indicated on the plans or in the proposal.

**1.0 DESCRIPTION.** Furnish, install, operate, and maintain variable message signs at the locations shown on the plans or designated by the Engineer. Remove and retain possession of variable message signs when they are no longer needed on the project.

#### **2.0 MATERIALS.**

**2.1 General.** Use LED Variable Message Signs Class I, II, or III, as appropriate, from the Department's List of Approved Materials.

Unclassified signs may be submitted for approval by the Engineer. The Engineer may require a daytime and nighttime demonstration. The Engineer will make a final decision within 30 days after all required information is received.

**2.2 Sign and Controls.** All signs must:

- 1) Provide 3-line messages with each line being 8 characters long and at least 18 inches tall. Each character comprises 35 pixels.
- 2) Provide at least 40 preprogrammed messages available for use at any time. Provide for quick and easy change of the displayed message; editing of the message; and additions of new messages.
- 3) Provide a controller consisting of:
  - a) Keyboard or keypad.
  - b) Readout that mimics the actual sign display. (When LCD or LCD type readout is used, include backlighting and heating or otherwise arrange for viewing in cold temperatures.)
  - c) Non-volatile memory or suitable memory with battery backup for storing pre-programmed messages.
  - d) Logic circuitry to control the sequence of messages and flash rate.
- 4) Provide a serial interface that is capable of supporting complete remote control ability through land line and cellular telephone operation. Include communication software capable of immediately updating the message, providing complete sign status, and allowing message library queries and updates.
- 5) Allow a single person easily to raise the sign to a satisfactory height above the pavement during use, and lower the sign during travel.
- 6) Be Highway Orange on all exterior surfaces of the trailer, supports, and controller cabinet.
- 7) Provide operation in ambient temperatures from -30 to + 120 degrees Fahrenheit during snow, rain and other inclement weather.
- 8) Provide the driver board as part of a module. All modules are interchangeable, and have plug and socket arrangements for disconnection and reconnection. Printed circuit boards associated with driver boards have a conformable coating to protect against moisture.
- 9) Provide a sign case sealed against rain, snow, dust, insects, etc. The lens is UV stabilized clear plastic (polycarbonate, acrylic, or other approved material) angled to prevent glare.
- 10) Provide a flat black UV protected coating on the sign hardware, character PCB, and appropriate lens areas.
- 11) Provide a photocell control to provide automatic dimming.

- 12) Allow an on-off flashing sequence at an adjustable rate.
- 13) Provide a sight to aim the message.
- 14) Provide a LED display color of approximately 590 nm amber.
- 15) Provide a controller that is password protected.
- 16) Provide a security device that prevents unauthorized individuals from accessing the controller.
- 17) Provide the following 3-line messages preprogrammed and available for use when the sign unit begins operation:

/KEEP/RIGHT/=>=>=>/	/MIN/SPEED/**MPH/
/KEEP/LEFT/<<<</	/ICY/BRIDGE/AHEAD/ /ONE
/LOOSE/GRAVEL/AHEAD/	LANE/BRIDGE/AHEAD/
/RD WORK/NEXT/**MILES/	/ROUGH/ROAD/AHEAD/
/TWO WAY/TRAFFIC/AHEAD/	/MERGING/TRAFFIC/AHEAD/
/PAINT/CREW/AHEAD/	/NEXT/***/MILES/
/REDUCE/SPEED/**MPH/	/HEAVY/TRAFFIC/AHEAD/
/BRIDGE/WORK/***0 FT/	/SPEED/LIMIT/**MPH/
/MAX/SPEED/**MPH/	/BUMP/AHEAD/
/SURVEY/PARTY/AHEAD/	/TWO/WAY/TRAFFIC/

\*Insert numerals as directed by the Engineer.  
Add other messages during the project when required by the Engineer.

**2.3 Power.**

- 1) Design solar panels to yield 10 percent or greater additional charge than sign consumption. Provide direct wiring for operation of the sign or arrow board from an external power source to provide energy backup for 21 days without sunlight and an on-board system charger with the ability to recharge completely discharged batteries in 24 hours.

**3.0 CONSTRUCTION.** Furnish and operate the variable message signs as designated on the plans or by the Engineer. Ensure the bottom of the message panel is a minimum of 7 feet above the roadway in urban areas and 5 feet above in rural areas when operating. Use Class I, II, or III signs on roads with a speed limit less than 55 mph. Use Class I or II signs on roads with speed limits 55 mph or greater.

Maintain the sign in proper working order, including repair of any damage done by others, until completion of the project. When the sign becomes inoperative, immediately repair or replace the sign. Repetitive problems with the same unit will be cause for rejection and replacement.

Use only project related messages and messages directed by the Engineer, unnecessary messages lessen the impact of the sign. Ensure the message is displayed in either one or 2 phases with each phase having no more than 3 lines of text. When no message is needed, but it is necessary to know if the sign is operable, flash only a pixel.

When the sign is not needed, move it outside the clear zone or where the Engineer directs. Variable Message Signs are the property of the Contractor and shall be removed from the project when no longer needed. The Department will not assume ownership of these signs.

**4.0 MEASUREMENT.** The final quantity of Variable Message Sign will be

11

the actual number of individual signs acceptably furnished and operated during the project. The Department will not measure signs replaced due to damage or rejection.

**5.0 PAYMENT.** The Department will pay for the Variable Message Signs at the unit price each. The Department will not pay for signs replaced due to damage or rejection. Payment is full compensation for furnishing all materials, labor, equipment, and service necessary to, operate, move, repair, and maintain or replace the variable message signs. The Department will make payment for the completed and accepted quantities under the following:

<u>Code</u>	<u>Pay Item</u>	<u>Pay Unit</u>
02671	Portable Changeable Message Sign	Each

Effective June 15, 2012

## 2016 KENTUCKY STANDARD DRAWINGS

CURVE WIDENING AND SUPERELEVATION TRANSITIONS .....	RGS-001-07
SUPERELEVATION FOR MULTILANE PAVEMENT .....	RGS-002-06
MISCELLANEOUS STANDARDS .....	RGX-001-06
APPROACHES, ENTRANCES, AND MAIL BOX TURNOUT .....	RPM-110-07
CENTERLINE RUMBLE STRIPS .....	TPM-150-02
CENTERLINE RUMBLE STRIP 4 INCH STRIPING .....	TPM-155-02
SHOULDER AND EDGE LINE RUMBLE STRIP DETAILS .....	TPM-165
LANE CLOSURE TWO-LANE HIGHWAY .....	TTC-100-04
SHOULDER CLOSURE .....	TTC-135-02
PAVEMENT CONDITION WARNING SIGNS .....	TTD-125-02
MOBILE OPERATION FOR PAINT STRIPING CASE I .....	TTS-100-02
MOBILE OPERATION FOR PAINT STRIPING CASE II .....	TTS-105-02

COUNT OF	SHEET NO.
TERMIN.	

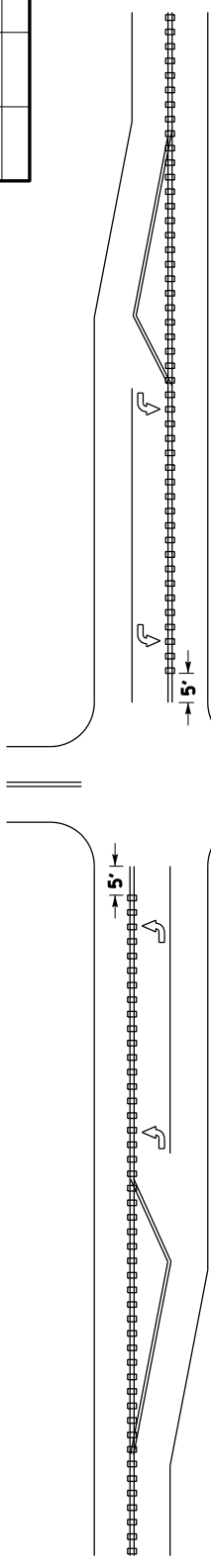

**INTERSECTIONS WITH LEFT-TURN LANES ①**

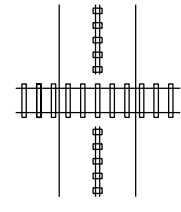

**HIGHWAY-RAIL GRADE CROSSINGS ③**

**INTERSECTIONS WITHOUT LEFT-TURN LANES ①**

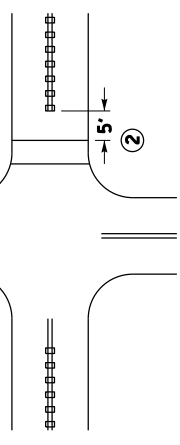

**APPROACH SLAB**

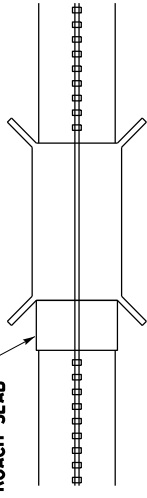

**BRIDGE DECK/APPROACH SLAB ④**

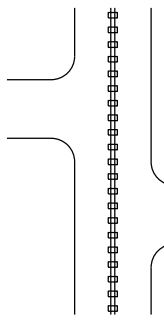

**DRIVEWAYS/MINOR COMMERCIAL ENTRANCES ⑤**

**NOTES ~**

- ① CENTERLINE RUMBLE STRIPS SHALL BE OMITTED THROUGH MAJOR INTERSECTIONS WITH, OR WITHOUT, LEFT-TURN LANES. OMIT THE CENTERLINE RUMBLE STRIPS APPROXIMATELY 5' IN ADVANCE OF THE AREA WHERE THE CENTERLINE PAVEMENT MARKINGS HAVE BEEN OMITTED (NORMALLY WHERE SIDE STREET RADIUS INTERSECTS MAINLINE).
- ② CENTERLINE RUMBLE STRIPS SHALL NOT BE INSTALLED THROUGH MARKED CROSSWALKS. OMIT THE CENTERLINE RUMBLE STRIPS APPROXIMATELY 5' IN ADVANCE OF MARKED CROSSWALKS.
- ③ CENTERLINE RUMBLE STRIPS SHALL NOT BE INSTALLED ACROSS HIGHWAY-RAIL GRADE CROSSINGS.
- ④ CENTERLINE RUMBLE STRIPS SHALL NOT BE INSTALLED ON BRIDGE DECKS OR APPROACH SLABS.
- ⑤ CENTERLINE RUMBLE STRIPS SHALL BE INSTALLED THROUGH DRIVEWAYS & MINOR COMMERCIAL ENTRANCES.
- 6. CENTERLINE RUMBLE STRIPS SHOULD BE OMITTED WHERE THE POSTED SPEED LIMIT IS 45 MPH OR LESS, OR WHERE LANE WIDTHS ARE LESS THAN 11 FT.

BID ITEM AND UNIT TO BID  
CENTERLINE RUMBLE STRIPS

LF

**DRAWING NOT TO SCALE**  
**USE WITH CUR. STD. DWGS. TPM-155 AND TPM-160**

KENTUCKY  
DEPARTMENT OF HIGHWAYS  
**CENTERLINE RUMBLE STRIPS**

SUBMITTED: *B. [Signature]*  
II-23-16  
DATE  
002



COUNTY OF	TITLING	SHEET

PLAN VIEW

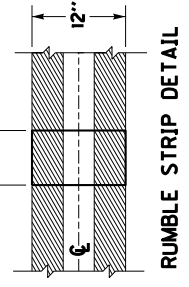
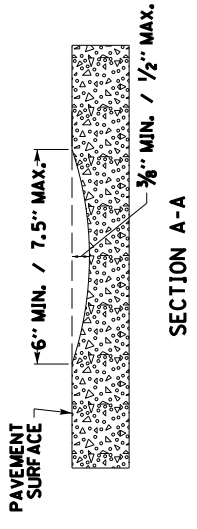
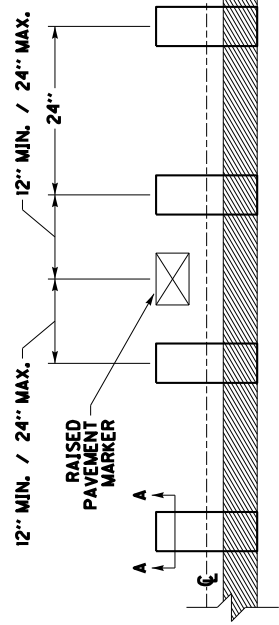
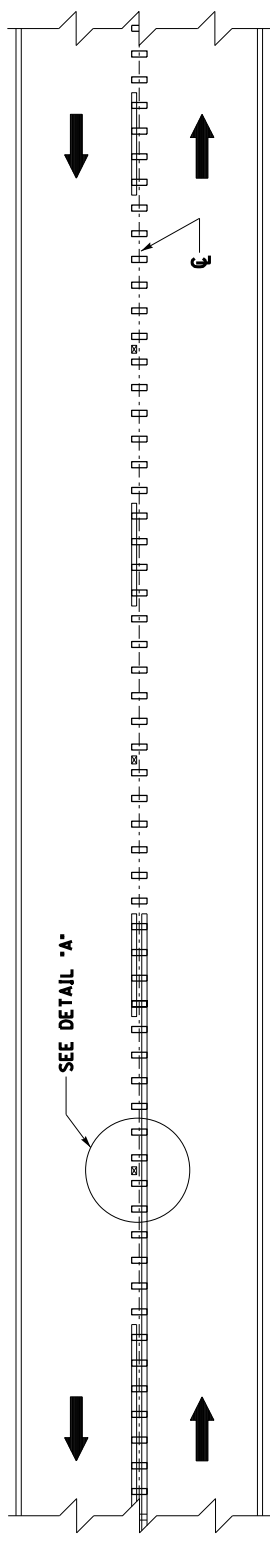

DETAIL 'A'

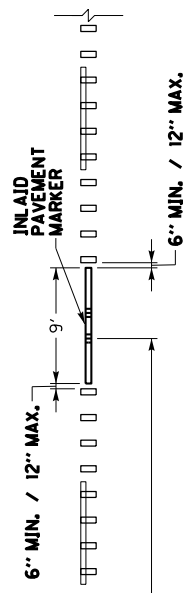
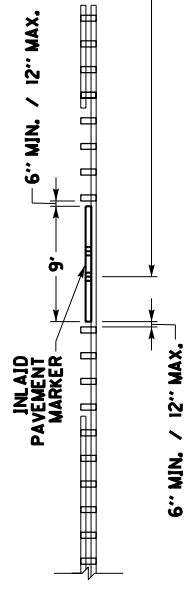

DETAIL FOR CENTERLINE RUMBLE STRIPS WITH INLAID PAVEMENT MARKERS

NOTES

1. DISTANCES SHOWN ARE APPROXIMATE. MAINTAIN RUMBLE STRIP DIMENSIONS AND SPACING AS MUCH AS POSSIBLE.
2. CENTERLINE RUMBLE STRIPS SHALL BE INSTALLED IN LINE WITH THE CENTER OF THE ROADWAY AS MUCH AS POSSIBLE.
3. DISCONTINUE CENTERLINE RUMBLE STRIPS AT LEAST 12" BEFORE AND AFTER THE CENTER OF EACH RAISED PAVEMENT MARKER, AND AT LEAST 6" BEFORE AND AFTER THE GROOVE FOR EACH INLAID PAVEMENT MARKER, INSTALL AS MANY RUMBLE STRIPS AS POSSIBLE BETWEEN ADJACENT PAVEMENT MARKERS WHILE MAINTAINING THE 24" CYCLE.
4. DO NOT INSTALL CENTERLINE RUMBLE STRIPS IN AREAS INDICATED ON TPM-150.
5. CENTERLINE RUMBLE STRIPS SHOULD BE OMITTED WHERE THE POSTED SPEED LIMIT IS 45 MPH OR LESS, OR WHERE LANE WIDTHS ARE LESS THAN 11 FT.

BID ITEM AND UNIT TO BID  
CENTERLINE RUMBLE STRIPS

LF

DRAWING NOT TO SCALE

USE WITH CUR. STD. DWG.  
TPM-150

KENTUCKY  
DEPARTMENT OF HIGHWAYS

CENTERLINE  
RUMBLE STRIPS  
4 INCH STRIPING

SUBMITTED: *B. [Signature]*  
11-23-16  
DWG  
003

COUNT OF	SHEET NO.
TERMINI	

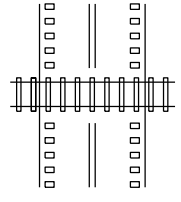
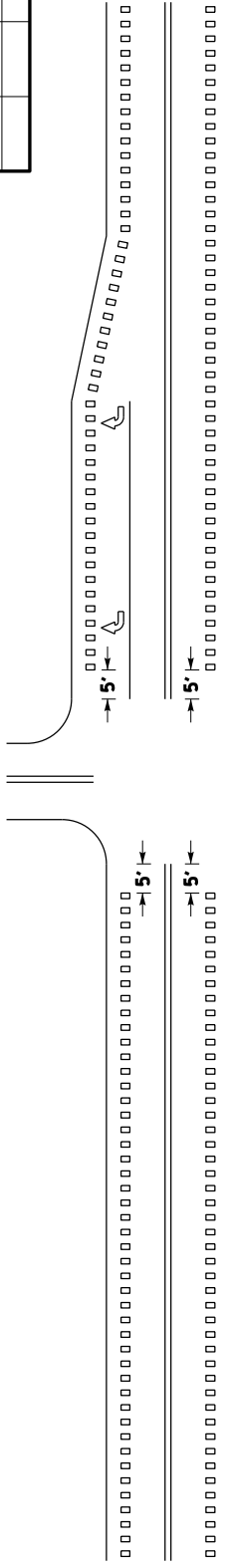

HIGHWAY-RAIL GRADE CROSSINGS ③

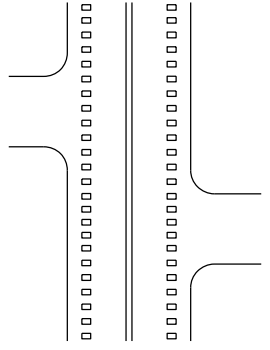

DRIVEWAYS/MINOR COMMERCIAL ENTRANCES ⑤

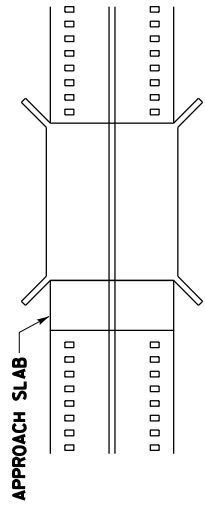

BRIDGE DECK/APPROACH SLAB ④

MAILBOX TURNOUTS ⑥

~ NOTES ~

- ① RUMBLE STRIPS SHALL BE OMITTED THROUGH MAJOR INTERSECTIONS WITH, OR WITHOUT, RIGHT-TURN LANES. OMIT RUMBLE STRIPS APPROXIMATELY 5' IN ADVANCE OF THE AREA WHERE EDGELINE PAVEMENT MARKINGS HAVE BEEN OMITTED (NORMALLY WHERE SIDE STREET RADIUS INTERSECTS MAINLINE).
- ② RUMBLE STRIPS SHALL NOT BE INSTALLED THROUGH MARKED CROSSWALKS. OMIT RUMBLE STRIPS APPROXIMATELY 5' IN ADVANCE OF MARKED CROSSWALKS.
- ③ RUMBLE STRIPS SHALL NOT BE INSTALLED ACROSS HIGHWAY-RAIL GRADE CROSSINGS.
- ④ RUMBLE STRIPS SHALL NOT BE INSTALLED ON BRIDGE DECKS OR APPROACH SLABS.
- ⑤ RUMBLE STRIPS SHALL BE INSTALLED THROUGH DRIVEWAYS & MINOR COMMERCIAL ENTRANCES.
- ⑥ RUMBLE STRIPS SHALL BE INSTALLED THROUGH MAILBOX TURNOUTS.
7. RUMBLE STRIPS SHOULD BE OMITTED WHERE THE POSTED SPEED LIMIT IS 45 MPH OR LESS.

DRAWING NOT TO SCALE

USE WITH SEP1A 006, 007, AND 008

KENTUCKY  
DEPARTMENT OF HIGHWAYS  
SHOULDER & EDGELINE  
RUMBLE STRIP DETAILS

SUBMITTED: *B. [Signature]* DATE: 11-23-16  
005

BID ITEMS AND UNIT TO BID  
EDGELINE RUMBLE STRIPS  
SHOULDER RUMBLE STRIPS

LF  
LF

COUNTY OF	TITLING	SHEET

PAVEMENT WIDTH (W) ②	RUMBLE LENGTH (X) ⑤	OFFSET ⑥	CLRS & SRS	
			LANE WIDTH (Y) ③	SHOULDER WIDTH (Z) ④
34'	8"	6"	12'	5'
35'	8"	6"	12'	5.5'
36'	8"	6"	12'	6'
37'	12"	12"	12'	6.5'
38'	12"	12"	12'	7'
39'	12"	12"	12'	7.5'
>=40'	16"	12"	12'	>=8'

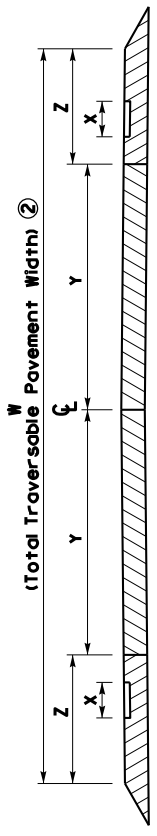

PAVEMENT CROSS-SECTION

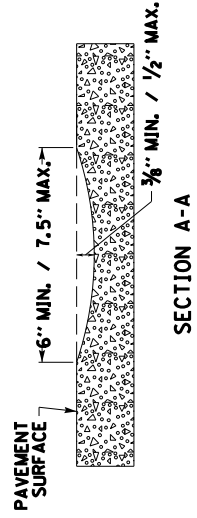
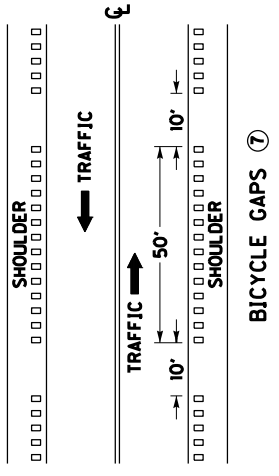
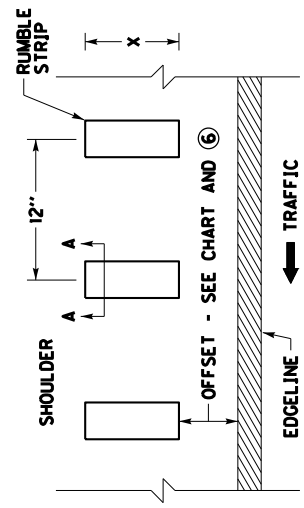

~ NOTES ~

- SHOULDER RUMBLE STRIPS SHOULD BE INSTALLED ACCORDING TO THE DIMENSIONS PROPOSED ABOVE UNLESS THERE IS AN ENGINEERING BASIS THAT SUPPORTS A CHANGE IN DIMENSION. FOR EXAMPLE, IF THE EXISTING LANE WIDTH IS NARROWER THAN THE LANE WIDTH PROPOSED IN THIS DRAWING AND THE EXISTING SHOULDER PAVEMENT DEPTH IS NOT SUITABLE TO BE CONVERTED INTO A PORTION OF THE PROPOSED LANE WIDTH, THEN THE EXISTING LANE WIDTH SHOULD BE USED INSTEAD OF THE WIDTH PROPOSED IN THIS DRAWING.
- PAVEMENT WIDTH (W) IS THE TOTAL WIDTH OF TRAVERSABLE PAVEMENT. DO NOT INCLUDE THE WIDTH OF ANY NON-TRAVERSABLE PAVEMENT, SUCH AS PAVEMENT WEDGES, WHEN MEASURING THE PAVEMENT WIDTH (W).
- LANE WIDTH (Y) TO BE MEASURED FROM CENTER OF ROAD TO CENTER OF EDGE LINE STRIPE.
- PAVED SHOULDER WIDTH (Z) TO BE MEASURED FROM CENTER OF EDGE LINE STRIPE TO OUTSIDE EDGE OF TRAVERSABLE PAVEMENT. DISTANCES SHOWN ARE APPROXIMATE. MAINTAIN RUMBLE STRIP DIMENSIONS AND SPACING AS MUCH AS POSSIBLE. IF THE TYPICAL SECTION SHOWS A LANE WIDTH (Y) AND/OR SHOULDER WIDTH (Z) THAT DIFFERS FROM THE WIDTHS LISTED IN THIS DRAWING, THE ENGINEER SHALL DETERMINE THE LANE WIDTH (Y) AND/OR SHOULDER WIDTH (Z) AT THE TIME OF CONSTRUCTION.
- NOTE: CENTERLINE RUMBLE STRIPS SHOULD BE OMITTED WHEN THE LANE WIDTH (Y) IS LESS THAN 11 FT.
- RUMBLE LENGTH (X) AND/OR OFFSET DISTANCE MAY BE MODIFIED AS THE ENGINEER DIRECTS, IF THE SHOULDER WIDTH (Z) IS EQUAL TO OR LESS THAN THE COMBINED WIDTH OF THE PROPOSED RUMBLE LENGTH (X) AND OFFSET DISTANCE.
- ALL SHOULDER RUMBLE STRIPS ALONG SHOULDERS THAT ARE 5' OR WIDER SHOULD INCLUDE BICYCLE GAPS AS DETAILED.
- SHOULDER RUMBLE STRIPS SHOULD BE OMITTED WHERE THE POSTED SPEED LIMIT IS 45 MPH OR LESS.

DRAWING NOT TO SCALE

USE WITH SEP1A 005  
KENTUCKY  
DEPARTMENT OF HIGHWAYS  
SHOULDER RUMBLE STRIP  
DETAILS  
TWO LANE ROADWAYS  
SUBMITTED: *B. [Signature]* DATE: 11-23-16  
007

BID ITEM AND UNIT TO BID  
SHOULDER RUMBLE STRIPS

LF

## **PART III**

### **EMPLOYMENT, WAGE AND RECORD REQUIREMENTS**

**TRANSPORTATION CABINET  
DEPARTMENT OF HIGHWAYS**

**LABOR AND WAGE REQUIREMENTS  
APPLICABLE TO OTHER THAN FEDERAL-AID SYSTEM PROJECTS**

- I. Application
- II. Nondiscrimination of Employees (KRS 344)

**I. APPLICATION**

1. These contract provisions shall apply to all work performed on the contract by the contractor with his own organization and with the assistance of workmen under his immediate superintendence and to all work performed on the contract by piecework, station work or by subcontract. The contractor's organization shall be construed to include only workmen employed and paid directly by the contractor and equipment owned or rented by him, with or without operators.

2. The contractor shall insert in each of his subcontracts all of the stipulations contained in these Required Provisions and such other stipulations as may be required.

3. A breach of any of the stipulations contained in these Required Provisions may be grounds for termination of the contract.

3. If the contractor is in control of apprenticeship or other training or retraining, including on-the-job training programs, he shall not discriminate against an individual because of his race, color, religion, national origin, sex, disability or age forty (40) and over, in admission to, or employment in any program established to provide apprenticeship or other training.

4. The contractor will send to each labor union or representative of workers with which he has a collective bargaining agreement or other contract or understanding, a notice to be provided advising the said labor union or workers' representative of the contractor's commitments under this section, and shall post copies of the notice in conspicuous places available to employees and applicants for employment. The contractor will take such action with respect to any subcontract or purchase order as the administrating agency may direct as a means of enforcing such provisions, including sanctions for non-compliance.

Revised: January 25, 2017

**II. NONDISCRIMINATION OF EMPLOYEES**

**AN ACT OF THE KENTUCKY  
GENERAL ASSEMBLY TO PREVENT  
DISCRIMINATION IN EMPLOYMENT  
KRS CHAPTER 344  
EFFECTIVE JUNE 16, 1972**

The contract on this project, in accordance with KRS Chapter 344, provides that during the performance of this contract, the contractor agrees as follows:

1. The contractor shall not fail or refuse to hire, or shall not discharge any individual, or otherwise discriminate against an individual with respect to his compensation, terms, conditions, or privileges of employment, because of such individual's race, color, religion, national origin, sex, disability or age (forty and above); or limit, segregate, or classify his employees in any way which would deprive or tend to deprive an individual of employment opportunities or otherwise adversely affect his status as an employee, because of such individual's race, color, religion, national origin, sex, disability or age forty (40) and over. The contractor agrees to post in conspicuous places, available to employees and applicants for employment, notices to be provided setting forth the provisions of this nondiscrimination clause.

2. The contractor shall not print or publish or cause to be printed or published a notice or advertisement relating to employment by such an employer or membership in or any classification or referral for employment by the employment agency, indicating any preference, limitation, specification, or discrimination, based on race, color, religion, national origin, sex, or age forty (40) and over, or because the person is a qualified individual with a disability, except that such a notice or advertisement may indicate a preference, limitation, or specification based on religion, national origin, sex, or age forty (40) and over, or because the person is a qualified individual with a disability, when religion, national origin, sex, or age forty (40) and over, or because the person is a qualified individual with a disability, is a bona fide occupational qualification for employment.

## EXECUTIVE BRANCH CODE OF ETHICS

In the 1992 regular legislative session, the General Assembly passed and Governor Brereton Jones signed Senate Bill 63 (codified as KRS 11A), the Executive Branch Code of Ethics, which states, in part:

KRS 11A.040 (7) provides:

No present or former public servant shall, within six (6) months following termination of his office or employment, accept employment, compensation, or other economic benefit from any person or business that contracts or does business with, or is regulated by, the state in matters in which he was directly involved during the last thirty-six (36) months of his tenure. This provision shall not prohibit an individual from returning to the same business, firm, occupation, or profession in which he was involved prior to taking office or beginning his term of employment, or for which he received, prior to his state employment, a professional degree or license, provided that, for a period of six (6) months, he personally refrains from working on any matter in which he was directly involved during the last thirty-six (36) months of his tenure in state government. This subsection shall not prohibit the performance of ministerial functions, including but not limited to filing tax returns, filing applications for permits or licenses, or filing incorporation papers, nor shall it prohibit the former officer or public servant from receiving public funds disbursed through entitlement programs.

KRS 11A.040 (9) states:

A former public servant shall not represent a person or business before a state agency in a matter in which the former public servant was directly involved during the last thirty-six (36) months of his tenure, for a period of one (1) year after the latter of:

- a) The date of leaving office or termination of employment; or
- b) The date the term of office expires to which the public servant was elected.

This law is intended to promote public confidence in the integrity of state government and to declare as public policy the idea that state employees should view their work as a public trust and not as a way to obtain private benefits.

If you have worked for the executive branch of state government within the past six months, you may be subject to the law's prohibitions. The law's applicability may be different if you hold elected office or are contemplating representation of another before a state agency.

Also, if you are affiliated with a firm which does business with the state and which employs former state executive-branch employees, you should be aware that the law may apply to them.

In case of doubt, the law permits you to request an advisory opinion from the Executive Branch Ethics Commission, 3 Fountain Place, Frankfort, Kentucky 40601; telephone (502) 564-7954.

Revised: January 27, 2017

### **Kentucky Equal Employment Opportunity Act of 1978**

The requirements of the Kentucky Equal Employment Opportunity Act of 1978 (KRS 45.560-45.640) shall apply to this Contract. The apparent low Bidder will be required to submit EEO forms to the Division of Construction Procurement, which will then forward to the Finance and Administration Cabinet for review and approval. No award will become effective until all forms are submitted and EEO/CC has certified compliance. The required EEO forms are as follows:

- EEO-1: Employer Information Report
- Affidavit of Intent to Comply
- Employee Data Sheet
- Subcontractor Report

These forms are available on the Finance and Administration's web page under ***Vendor Information, Standard Attachments and General Terms*** at the following address:  
**<https://www.eProcurement.ky.gov>**.

Bidders currently certified as being in compliance by the Finance and Administration Cabinet may submit a copy of their approval letter in lieu of the referenced EEO forms.

For questions or assistance please contact the Finance and Administration Cabinet by email at **[finance.contractcompliance@ky.gov](mailto:finance.contractcompliance@ky.gov)** or by phone at 502-564-2874.

# EMPLOYEE RIGHTS UNDER THE FAIR LABOR STANDARDS ACT

THE UNITED STATES DEPARTMENT OF LABOR WAGE AND HOUR DIVISION

## FEDERAL MINIMUM WAGE

# \$7.25 PER HOUR

BEGINNING JULY 24, 2009

**OVERTIME PAY** At least 1½ times your regular rate of pay for all hours worked over 40 in a workweek.

**CHILD LABOR** An employee must be at least **16** years old to work in most non-farm jobs and at least **18** to work in non-farm jobs declared hazardous by the Secretary of Labor.

Youths **14** and **15** years old may work outside school hours in various non-manufacturing, non-mining, non-hazardous jobs under the following conditions:

**No more than**

- **3** hours on a school day or **18** hours in a school week;
- **8** hours on a non-school day or **40** hours in a non-school week.

Also, work may not begin before **7 a.m.** or end after **7 p.m.**, except from June 1 through Labor Day, when evening hours are extended to **9 p.m.** Different rules apply in agricultural employment.

**TIP CREDIT** Employers of “tipped employees” must pay a cash wage of at least \$2.13 per hour if they claim a tip credit against their minimum wage obligation. If an employee’s tips combined with the employer’s cash wage of at least \$2.13 per hour do not equal the minimum hourly wage, the employer must make up the difference. Certain other conditions must also be met.

**ENFORCEMENT** The Department of Labor may recover back wages either administratively or through court action, for the employees that have been underpaid in violation of the law. Violations may result in civil or criminal action.

Employers may be assessed civil money penalties of up to \$1,100 for each willful or repeated violation of the minimum wage or overtime pay provisions of the law and up to \$11,000 for each employee who is the subject of a violation of the Act’s child labor provisions. In addition, a civil money penalty of up to \$50,000 may be assessed for each child labor violation that causes the death or serious injury of any minor employee, and such assessments may be doubled, up to \$100,000, when the violations are determined to be willful or repeated. The law also prohibits discriminating against or discharging workers who file a complaint or participate in any proceeding under the Act.

### ADDITIONAL INFORMATION

- Certain occupations and establishments are exempt from the minimum wage and/or overtime pay provisions.
- Special provisions apply to workers in American Samoa and the Commonwealth of the Northern Mariana Islands.
- Some state laws provide greater employee protections; employers must comply with both.
- The law requires employers to display this poster where employees can readily see it.
- Employees under 20 years of age may be paid \$4.25 per hour during their first 90 consecutive calendar days of employment with an employer.
- Certain full-time students, student learners, apprentices, and workers with disabilities may be paid less than the minimum wage under special certificates issued by the Department of Labor.

For additional information:



# 1-866-4-USWAGE

(1-866-487-9243) TTY: 1-877-889-5627



# WWW.WAGEHOUR.DOL.GOV



**PART IV**  
**INSURANCE**

## INSURANCE

The Contractor shall procure and maintain the following insurance in addition to the insurance required by law:

- 1) Commercial General Liability-Occurrence form – not less than \$2,000,000 General aggregate, \$2,000,000 Products & Completed Aggregate, \$1,000,000 Personal & Advertising, \$1,000,000 each occurrence.
- 2) Automobile Liability- \$1,000,000 per accident
- 3) Employers Liability:
  - a) \$100,000 Each Accident Bodily Injury
  - b) \$500,000 Policy limit Bodily Injury by Disease
  - c) \$100,000 Each Employee Bodily Injury by Disease
- 4) The insurance required above must be evidenced by a Certificate of Insurance and this Certificate of Insurance must contain one of the following statements:
  - a) "policy contains no deductible clauses."
  - b) "policy contains \_\_\_\_\_ (amount) deductible property damage clause but company will pay claim and collect the deductible from the insured."
- 5) **KENTUCKY WORKMEN'S COMPENSATION INSURANCE.** The contractor shall furnish evidence of coverage of all his employees or give evidence of self-insurance by submitting a copy of a certificate issued by the Workmen's Compensation Board.

The cost of insurance is incidental to all contract items. All subcontractors must meet the same minimum insurance requirements.

**PART V**  
**BID ITEMS**

**PROPOSAL BID ITEMS**

192147

Page 1 of 1

Report Date 4/23/19

**Section: 0001 - PAVING**

LINE	BID CODE	ALT	DESCRIPTION	QUANTITY	UNIT	UNIT PRIC	FP	AMOUNT
0010	00190		LEVELING & WEDGING PG64-22	825.00	TON		\$	
0020	00301		CL2 ASPH SURF 0.38D PG64-22	3,720.00	TON		\$	
0030	00388		CL3 ASPH SURF 0.38B PG64-22	7,455.00	TON		\$	
0040	02562		TEMPORARY SIGNS	430.00	SQFT		\$	
0050	02650		MAINTAIN & CONTROL TRAFFIC	1.00	LS		\$	
0060	02671		PORTABLE CHANGEABLE MESSAGE SIGN	2.00	EACH		\$	
0070	02676		MOBILIZATION FOR MILL & TEXT	1.00	LS		\$	
0080	02677		ASPHALT PAVE MILLING & TEXTURING	220.00	TON		\$	
0090	02696		SHOULDER RUMBLE STRIPS	49,000.00	LF		\$	
0100	02775		ARROW PANEL	2.00	EACH		\$	
0110	04792		CONDUIT-1 IN	60.00	LF		\$	
0120	04793		CONDUIT-1 1/4 IN	280.00	LF		\$	
0130	04795		CONDUIT-2 IN	60.00	LF		\$	
0140	04811		ELECTRICAL JUNCTION BOX TYPE B	3.00	EACH		\$	
0150	04820		TRENCHING AND BACKFILLING	600.00	LF		\$	
0160	04830		LOOP WIRE	872.00	LF		\$	
0170	04850		CABLE-NO. 14/1 PAIR	3,300.00	LF		\$	
0180	04895		LOOP SAW SLOT AND FILL	348.00	LF		\$	
0190	06510		PAVE STRIPING-TEMP PAINT-4 IN	40,000.00	LF		\$	
0200	06514		PAVE STRIPING-PERM PAINT-4 IN	90,000.00	LF		\$	
0230	06568		PAVE MARKING-THERMO STOP BAR-24IN	215.00	LF		\$	
0240	06569		PAVE MARKING-THERMO CROSS-HATCH	3,000.00	SQFT		\$	
0250	06574		PAVE MARKING-THERMO CURV ARROW	7.00	EACH		\$	
0260	06578		PAVE MARKING-THERMO MERGE ARROW	24.00	EACH		\$	
0270	06600		REMOVE PAVEMENT MARKER TYPE V	850.00	EACH		\$	
0280	10020NS		FUEL ADJUSTMENT	16,803.00	DOLL	\$1.00	\$	\$16,803.00
0290	10030NS		ASPHALT ADJUSTMENT	42,204.00	DOLL	\$1.00	\$	\$42,204.00
0300	20458ES403		CENTERLINE RUMBLE STRIPS	26,500.00	LF		\$	
0310	24963ED		LOOP TEST	3.00	EACH		\$	
0320	24970EC		ASPHALT MATERIAL FOR TACK NON-TRACKING	50.00	TON		\$	

**Section: 0002 - DEMOBILIZATION**

LINE	BID CODE	ALT	DESCRIPTION	QUANTITY	UNIT	UNIT PRIC	FP	AMOUNT
0330	02569		DEMOBILIZATION	1.00	LS		\$	